

**line
210**

USER'S MANUAL



AMBROGIO
ROBOT

TABLE OF CONTENTS

EN

General information	2
Purpose of the manual.....	2
Identification of manufacturer and equipment.....	3
Safety information	3
Safety regulations.....	3
Safety devices.....	4
Safety signals.....	5
Technical information	6
Technical specifications.....	6
General description of the appliance.....	7
Main parts / standard equipment.....	8
Installation	9
Packing and unpacking.....	9
Planning of system installation.....	9
Setting up of the perimeter wire.....	11
Re-entry method to the charging station.....	11
Setup of the robot's quick re-entry to the charging station.....	12
Preparation and marking the boundaries of the work areas.....	13
Installation of perimeter wire.....	17
Installation of the charging station and power supply unit.....	18
Battery charging on first use.....	19
Adjustments	20
Adjustment recommendations.....	20
Adjustment of cutting height.....	20
Use and operation	21
Obligations for use.....	21
Description of robot commands.....	21
Menu access.....	21
Navigation.....	22
Settings – programming mode.....	24
Work schedules – programming mode.....	25
Secondary areas – programming mode.....	26
Safety – programming mode.....	26
Operating mode – programming mode.....	27
Language options – programming mode.....	27
Initial start up – automatic mode.....	27
Robot safety stop.....	28
Automatic return to the charging station.....	28
Use of the robot in closed areas with no charging station.....	28
Password entry.....	29
Visualising the display during the work phase.....	29
Prolonged inactivity and restarting.....	30
Battery charging after prolonged inactivity.....	31
Operating tips.....	32
Routine maintenance	32
Maintenance recommendations.....	32
Scheduled maintenance table.....	32
Robot cleaning.....	33
Troubleshooting.....	34
Troubleshooting guide	34
Part replacement	37
Recommendations for replacing parts.....	37
Battery replacement.....	37
Blade replacement.....	37
Robot disposal.....	38
EC declaration of conformity	39

Reproduction, even partial, of this document without written permission by the manufacturer is strictly forbidden. The manufacturer assumes a policy of continual improvement and reserves the right to modify this document without prior notice on condition that the changes do not constitute health and safety risks.
© 2008 – Text, illustrations and page layout by Tipolito La Zecca. The text may be reproduced, in whole or in part, on condition that the author is mentioned.

PURPOSE OF THE MANUAL

- This manual forms an integral part of the appliance and was produced by the Manufacturer to provide the necessary information to people authorised to interact with it during its working life.
- Operators of the appliance must adopt correct working practices and must carefully read and follow all the instructions contained in this manual.
- This manual is written by the Manufacturer in the original language of Italian and may be translated into other languages to meet legal and/or commercial requirements.
- Carefully read the instructions contained in this manual to avoid any unnecessary risks to people's health and safety, as well as economic damages.
- Keep this manual in a safe and easily accessible place for quick reference.
- Some information and illustrations contained in this manual may not perfectly correspond with the appliance in your possession; however, this does not affect its functioning.
- The Manufacturer reserves the right to make changes without any obligation to provide prior notice.
- The following symbols are used throughout this manual to highlight some particularly important information or to identify some important specifications.



Danger - Attention

This symbol indicates situations involving imminent danger, which, if ignored, could put people's health and safety at risk.



Warning – Caution

This symbol indicates situations where it is necessary to behave in a certain way in order to avoid putting people's health and safety at risk, and to protect the device.



Important

This symbol identifies particularly important technical information which must not be ignored.

IDENTIFICATION OF MANUFACTURER AND EQUIPMENT

The nameplate shown here is applied directly onto the appliance. It contains references and all the information essential for safely operating the device.

For any technical requirements, please contact the Manufacturer's Technical Service Centre or an authorised dealer.

For technical assistance, please indicate the data reported on the identification plate, the approximate hours of use and the type of fault detected.

- A. Name of manufacturer.
- B. CE conformity label.
- C. Model and Version / serial number / manufacturing year.
- D. Technical data: voltage, current, protection rating, mass, cutting width.

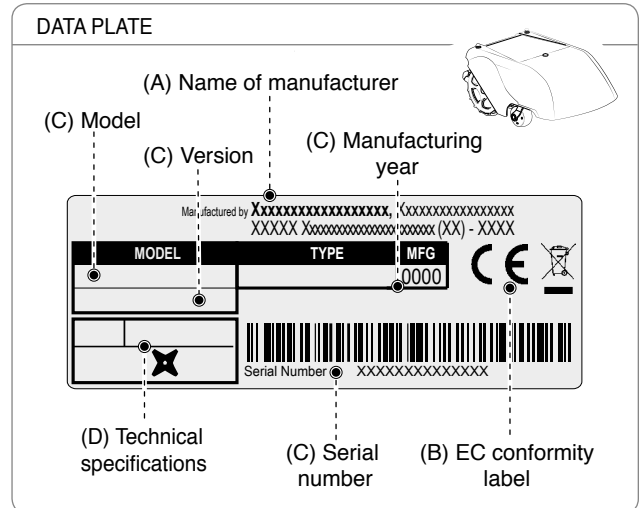

SAFETY INFORMATION

The manufacturer carefully considered the possible hazards and personal risks that may result from interacting with the equipment. The purpose of this information is to inform users on the need to use extreme caution in order to avoid risks.



SAFETY REGULATIONS



THIS PRODUCT COMES WITH A BLADE AND IS NOT A TOY!

- Please read the manual carefully, especially the safety instructions, and make sure you understand them fully before using the product. Only use the equipment for the purposes specifically intended by the manufacturer. Carefully follow the instructions on operation, maintenance and repair.
- When using the robot, make sure there is no one in the working area, in particular children, the elderly or disabled and pets. Otherwise, program the robot to operate during hours when there is no one in this area. Keep an eye on the robot if you know that pets, children or other people are in the area. If a person or animal is found on the robot's path, stop it immediately.
- Monitor the robot when it is operating in areas next to public or private areas that are not securely fenced off.
- This robot is not suitable for use by children and people with reduced physical, sensory or mental capabilities or inexperienced people who are not familiar with the product, unless they are supervised by a person responsible for their safety or have received instructions on how to use the appliance. Children should be supervised to ensure that they do not play with the appliance.
- Do not allow the robot to be used by people who do not know how it works.
- Operators who perform maintenance and repair work must be fully conversant with its special features and safety regulations. Before using the robot, carefully read the operating manual and make sure you understand the instructions.
- Never remove, bypass or tamper with the safety devices installed. The Manufacturer shall not be held liable if non-original spare parts are used. Failure to comply with this requirement may seriously endanger the health and safety of people.
- Check that there are no toys, tools, branches, clothing or other objects on the lawn which can damage the blades. Any objects on the lawn can also damage or prevent the correct functioning of the robot.

- Never allow people to sit on the robot. Never lift the robot to inspect the blade or to carry it while it is running. Do not place hands and feet under the robot when it is in operation.
- Do not use the robot when a sprinkler system is running. In this case, program the robot and the sprinkler system so that they do not operate at the same time. Do not wash the robot with high-pressure water jets and do not immerse it in water, partially or completely, as it is not watertight.
- Disconnect the power supply and activate the safety device before performing any adjustment or maintenance that the user is authorised to perform. Use the personal protection devices recommended by the Manufacturer, in particular, always wear protective gloves when handling the cutting blade.
- Cleaning and maintenance must not be performed by unsupervised children.
- Do not use the robot when the cutting blade is damaged. Replace the cutting blade.
- Do not use the robot when the top cover is damaged. If the mechanical parts of the robot are damaged, replace them.
- Do not use the robot if the power cord of the transformer is damaged. A damaged cord can lead to contact with live parts. To avoid any risk, have the cord replaced by the manufacturer or by its technical service centre or by a person with similar qualifications.
- Visually check the robot regularly to make sure the blade, mounting screws and cutting mechanism are not worn or damaged. Make sure that all the nuts, bolts and screws are tightened to ensure that the robot is in good working condition.
- Never use and recharge the robot in explosive and/or flammable environments.
- Only use the battery charger and power supply unit supplied by the manufacturer. Improper use may cause electric shocks, overheating or leakage of corrosive liquids from the battery. If any liquid leaks, wash the battery with water/neutraliser; in case of contact with eyes, seek medical attention.

SAFETY DEVICES

1. Bumpers

The bumper sensor is activated if the robot strikes a solid object greater than 10 cm (3.94 ") in height, which stops the movement in that direction and moves backwards to avoid the obstacle.

2. Inclinometer

If the robot works on a slope which is steeper than the maximum limit, or tips over, the robot will stop the cutting blade.

3. Emergency stop switch

Located on the upper part of the robot with the word "STOP" larger than the other commands on the keypad. Pressing this button at any time during operation will immediately stop the movement of the lawn mower robot and the rotation of the blade will stop.







4. Over-current protection

Each motor (blade and wheels) is monitored continuously during operation for any situation that may cause them to overheat. If this occurs in the wheel motor, the robot will attempt to move in the opposite direction. If the over-current persists, the robot will stop and signal an error. If the cutting blade motor overheats, there are two intervention ranges. If the parameters fall within the first range, the robot will perform the manoeuvres to unblock the cutting blade. If the over-current is below the protection range, the robot will stop and signal a motor error.

5. No signal sensor

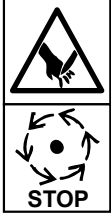
If there is no signal, the robot will automatically stop.

SAFETY SIGNALS

	<p>Read user instructions carefully to understand meanings before using the machine.</p>		<p>Keep an adequate safe distance from the machine while it is running.</p> <p>While the robot is working, make sure there are no people in the working area (especially children, elderly or disabled people) and pets. Keep children, pets and other people at a safe distance when the machine is functioning. To prevent that risk, we advise scheduling the robot's mowing activities at suitable times.</p>
	<p>Do not touch the rotary blade and do not place your hands or feet underneath the machine when it is running. Wait until the blade and rotating parts come to a complete stop before accessing.</p>		<p>Warning! Do not spray water on the machine to clean or wash it.</p> <p>While the robot is working, make sure there are no people in the working area (especially children, elderly or disabled people) and pets. Keep children, pets and other people at a safe distance when the machine is functioning. To prevent that risk, we advise scheduling the robot's mowing activities at suitable times.</p>
	<p>Do not ride on the machine.</p>		
	<p>Operate the safety device before working on or lifting the machine.</p>		

TECHNICAL INFORMATION

TECHNICAL SPECIFICATIONS

Description		Model			
		7200BA0	7200DE0	7200EL0	
		A	A	A	B
Maximum recommended surface that can be mowed					
Robot (*)	m ² (sq ')	1900 (20444 ')	2600 (27976 ')	2800 (30128 ')	3200 (34432')
Features					
Dimensions (W x H x D)	mm	800x390x610			
Robot weight (incl. battery)	kg	15,7		16,1	17,0
Cutting height (Min-Max)	mm (")	20-56 (0,79-2,25 ")			
Diameter of blade	mm (")	290 (11,42 ")			
Motors		with brushes		without brushes	
Cutting blade speed	RPM	4000 cutting			
		3000 maintenance		3000 maintenance	
Ground speed	Metres / Minute	28 (91.86 ')		30 (98.43 ')	
Maximum recommended slope managed (*)	%	45% allowable, based on the lawn conditions and accessories installed. 35% maximum managed and recommended in conditions of a trimmed lawn. 20% in proximity of the outside edge or perimeter wire.			
Ambient operating temperature	Max °C	ROBOT -10°(14 F.) (Min) +50° (122 F.) (Max) CARICABATTERIA -10°(14 F.) (Min) +40° (104 F.) (Max)			
Measured sound power level	dB(A)	75 (max) 65 (lawn maintenance)		70 (max) 65 (lawn maintenance)	
Water protection class	IP	IP21			
Electrical features					
Power supply unit (for lithium battery)		Input: 100 - 240 V~; 2 A - 1 A; 50/60 Hz; Class 1 Output: 29.4 V ===; 5.0 A			
Type of accumulator and charging batteries					
Rechargeable Lithium-Ion Battery (rated voltage)		25.9V - 7.5Ah			25.9V 2x7.5Ah
Battery charger		29.4 Vcc - 5.0 A			
Average recharging time	hh:mm	3:00			5:00
Average mowing duration after a full charge cycle (*)	hh:mm	3:00		3:30	6:00
Blade safety stop					
Rollover sensor		standard			
Emergency button		standard			

(*) Depending on the condition of the grass and lawn surface

Equipment / Accessories / Functions				
Maximum length of perimeter wire (approximate, calculated based on a regular perimeter)	m (')	1000 (3280')		
Areas managed, including the primary one		3	4	
Rain sensor		standard		
Mowed lawn sensor – Self-programming (patented)		not available	standard	standard
SMS Alert		not available		optional

(*) Depending on the condition of the grass and lawn surface

GENERAL DESCRIPTION OF THE APPLIANCE

The appliance is a robot designed and built to automatically trim grass in gardens and house lawns at any time of the day or night. It is small, compact, silent and easy to transport.

Depending on the characteristics of the surface to be trimmed, the robot can be programmed to work on more than one area: a primary area and secondary areas (according to the specifications of the various models).

During operation, the robot trims the area marked off by the perimeter wire.

When the robot detects the perimeter wire or encounters an obstacle, it changes direction in a random manner and starts mowing again in a new direction.

According to its operating principle random, the robot automatically trims the entire delimited area of the lawn (see figure).

The robot is able to recognise the presence of higher and/or thicker grass in an area of the garden and to automatically activate, if considered necessary, the spiral movement for a perfect finish. The spiral movement can also be activated by pressing “ENTER” while the robot is mowing.

The lawn surface that the robot is able to trim depends on a series of factors, such as:

- model of the robot and type of batteries installed;
- characteristics of the area (irregular perimeters, uneven surfaces, divided areas, etc.);
- characteristics of the lawn (type and height of the grass, moisture, etc.);
- conditions of the blade (level of sharpness, without residuals and deposits, etc.).

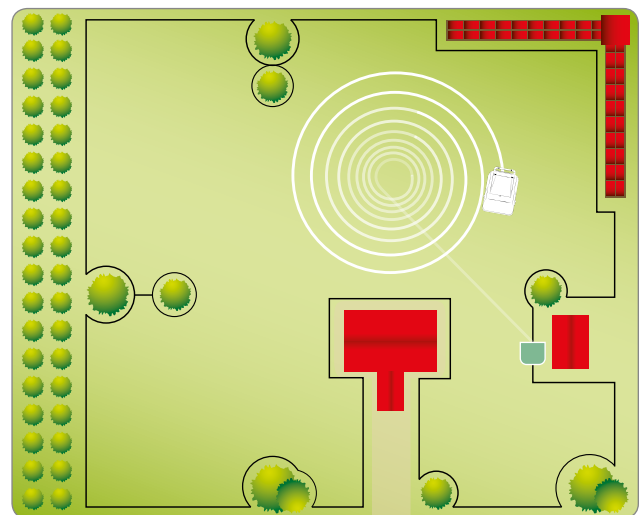
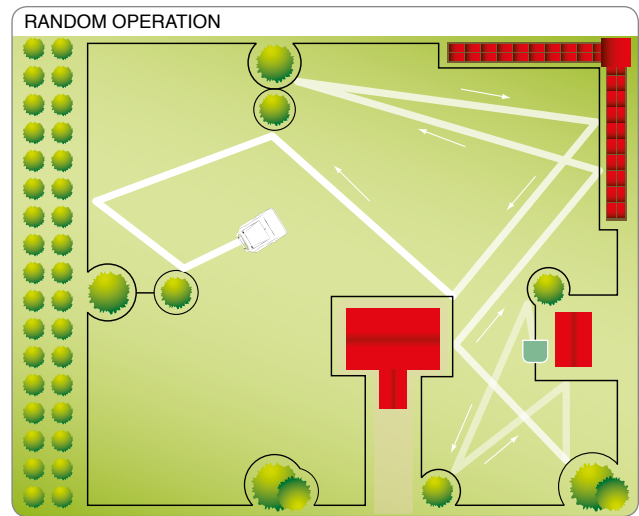

MAIN PARTS

EN

MODEL		7200BA0	7200DE0	7200EL0	
Version		A	A	A	B
①	Robot	✓	✓	✓	✓
②	Keyboard commands	✓	✓	✓	✓
③	Rain sensor	✓	✓	✓	✓
④	Battery	7.5Ah	7.5Ah	7.5Ah	15Ah
⑤	Handle	✓	✓	✓	✓
⑥	Cutting blade	✓	✓	✓	✓
⑦	Perimeter wire coil	-	-	-	-
⑧	Pegs	20	20	20	20
⑨	Power cord for the power supply unit	✓	✓	✓	✓
⑩	Power Supply unit	✓	✓	✓	✓
⑪	Charging station	✓	✓	✓	✓
⑫	Transmitter	✓	✓	✓	✓
⑬	User manual	✓	✓	✓	✓
⑭	Key for adjusting the cutting height	✓	✓	✓	✓
⑮	Joint for perimeter wire	-	-	-	-

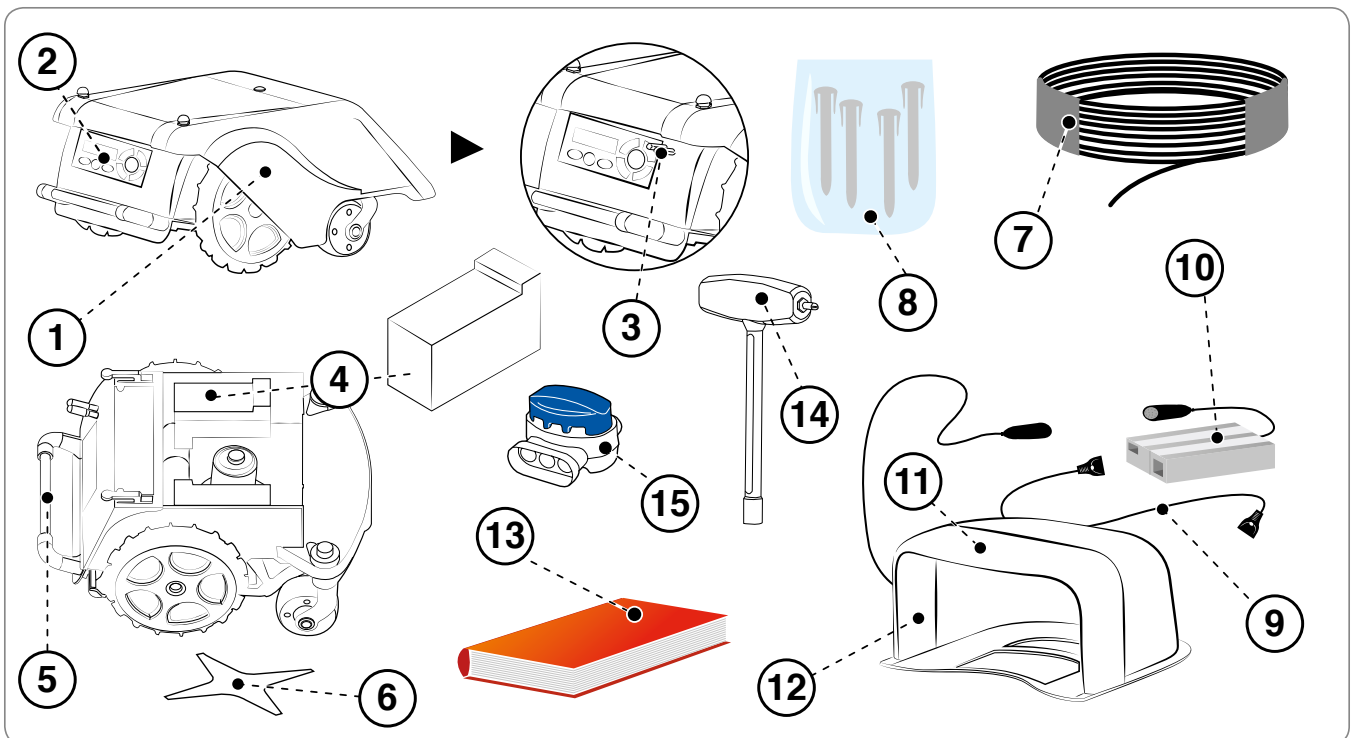

PACKING AND UNPACKING

The equipment is delivered suitably packaged. When unpacking, carefully remove and check the integrity of the parts.



Warning – Caution

Keep plastic wrapping and plastic containers away from infants and children: risk of suffocation!



Important

Keep the packaging materials for future use.

PLANNING OF SYSTEM INSTALLATION

The robot is not difficult to install, but requires some preliminary planning in order to find the best area for installing the charging station, power supply unit and for laying out the perimeter wire.

- The charging station must be positioned on the edge of the lawn, preferably in the largest area from which other areas of the lawn are easily accessible. The area where the charging station is installed is hereinafter referred to as the “Primary Area.”



Warning – Caution

Position the power supply unit in an area that cannot be reached by children. For example, at a height above 160 cm (63").



Warning – Caution

Make sure only authorised people have access to the power supply.



Warning – Caution

When connecting the electricity, it is necessary that a power outlet is positioned near the installation area. Make sure the connection to the mains power complies with the applicable laws. To operate in complete safety, make sure the electrical system, which is connected to the power supply unit, is equipped with a well-functioning earthing system. The supply circuit shall be protected by a residual current device (RCD) with a tripping current of not more than 30 mA.



Important

It is advisable to install the unit in a cabinet for electric components (for outdoor or indoor use), equipped with a key lock, and well-ventilated to maintain a correct air circulation.

- The robot must be able to easily find the charging station at the end of the work cycle, which will also be the starting point for a new work cycle and for reaching any other work areas, hereinafter referred to as “Secondary Areas.”
- Position the charging station according to these rules:
 - on level ground;
 - on compact and stable ground with good drainage;
 - preferably in the widest part of the lawn;
 - in case of sprinklers, make sure the water jets are not directed inside the charging station;
 - make sure the entrance of the charging station is positioned as shown in the figure, so that the robot can enter it by following the perimeter wire in a clockwise direction;
 - there must be a straight area of 200 cm (78,74 ") in front of the charging station;
 - any metal bars or rails separating the lawn near the station may interfere with the signal. Position the station on a different side of the garden or at a safe distance from the metal barrier. For more information, please contact the Manufacturer’s Technical Service Centre or an authorised dealer.
- The charging station must be well fastened to the ground. To prevent a small step from forming at the front of the charging station, position a small piece of fake grass at its entrance to stop this from occurring. Alternatively, remove part of the grassy surface and install the charging station flush with the grass.

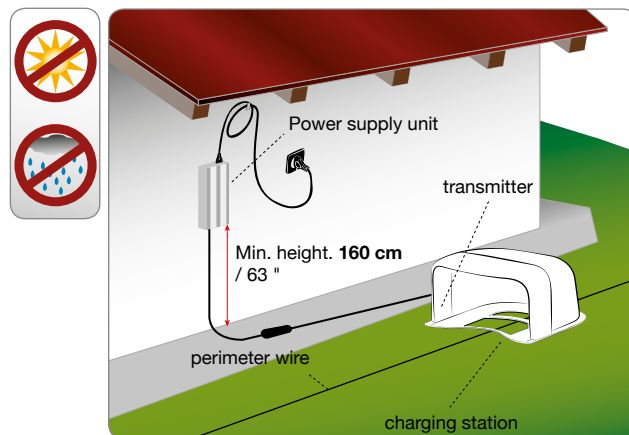

- The charging station is connected to the power supply unit via a cord that must move away from the charging station on the outside of the cutting area.

- Position the power supply unit according to these rules:

- in a well-ventilated area protected against atmospheric agents and direct sunlight;
- preferably inside your home, a garage or shed;
- if positioned outdoors, the robot must not be exposed to direct sunlight and water. Therefore, it must be protected inside a ventilated box. Do not position in direct contact with the soil or humid environments;
- position it on the outside of the lawn and not inside;
- stretch out the excess cord going from the charging station to the power supply unit. Do not shorten or lengthen the cord.

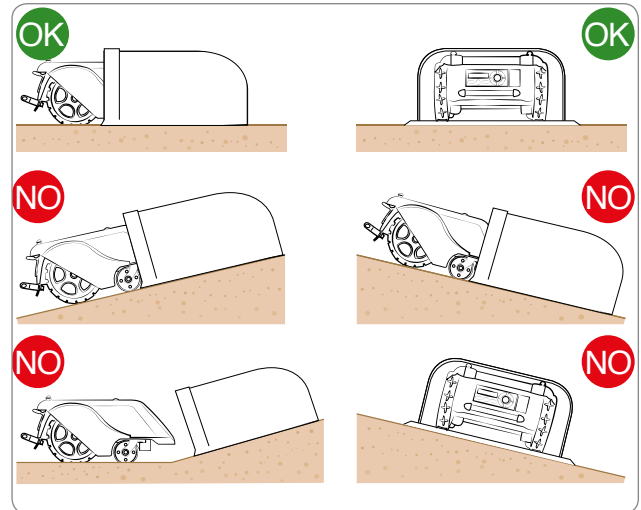

- The incoming section of the wire must be straight and aligned perpendicularly to the charging station by at least 200 cm (78.74 in.) and the outgoing section must move away from the charging station; this allows the correct re-entry of the robot.

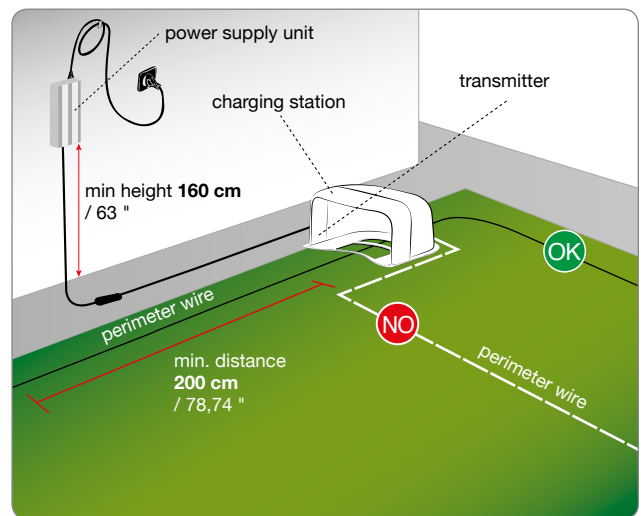

If the robot is installed near an area which has another robot (from the same or another manufacturer), then the transmitter and receiver of the robot must be modified during installation so that the frequencies of the two robots do not interfere with other. In this situation, contact the closest customer service centre.

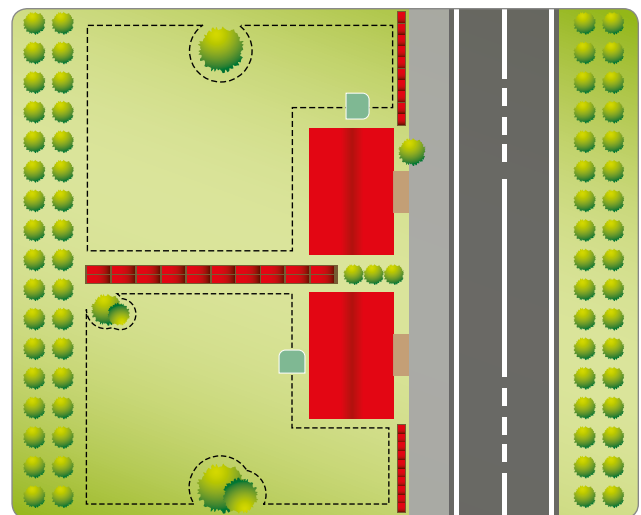

SETTING UP OF THE PERIMETER WIRE

Before installing the perimeter wire, it is necessary to check the entire surface of the lawn. Make any necessary adjustments to the grassy surface during the laying of the perimeter wire in order to allow the robot to function correctly.

1. Evaluate the best method for returning to the charging station according to the instructions described in the chapter "RE-ENTRY METHOD TO THE CHARGING STATION".
2. Evaluate whether a special installation of the perimeter wire is necessary according to the instructions described in the chapter "SET-UP OF THE ROBOT'S QUICK RE-ENTRY TO THE CHARGING STATION".
3. Preparation and defining of the work areas.
4. Installation of the perimeter wire.
5. Installation of the charging station and power supply unit. When laying the perimeter wire, respect the installation direction (clockwise) and the rotation direction around the flowerbeds (counter-clockwise). As shown in the figure.

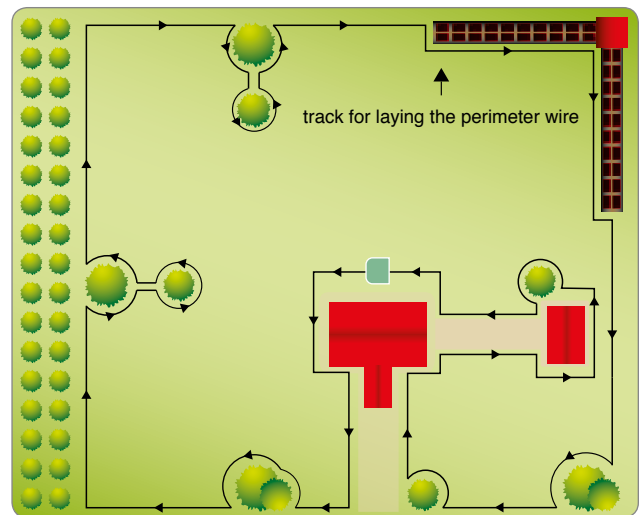

RE-ENTRY METHOD TO THE CHARGING STATION

The robot can return to the charging station in two different ways based on what is set in the user menu under the field "Settings – Re-entry to Base." Use the "On the Wire" method only when there are numerous obstacles inside the garden and near the perimeter wire (within 2 meters). In all other cases it is better to use the "V-Meter" method for the quickest re-entry to the charging station.

"Follow wire". This method of re-entry to the charging station commands the robot to follow the perimeter wire, positioning its wheels on either side of the wire. If this method is activated, there is no need to prepare the "Recall on Wire" as described below.

"V-Meter". By setting this method of re-entry to the charging station, the robot runs along the perimeter wire at an indicative distance ranging from a few centimetres to one meter (3.2'), touching it every now and again in the curved sections until the signal emitted by the charging station has been recognised for guiding itself on the wire and entering correctly into the charging station.

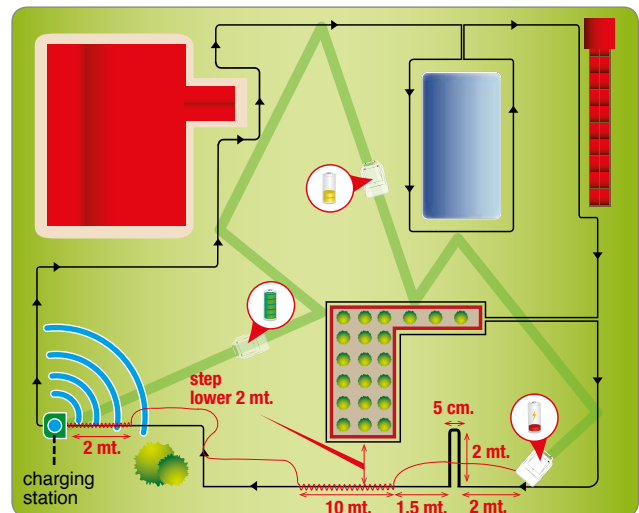

If narrow passages are present or the arrow for quick re-entry to the charging station, the wire must be positioned in a special way, called "Recall on the wire."

As soon as a "Recall" is recognised, the robot will follow the perimeter wire at low speed, and with more precision for around 10 meters (33'). It will then return to the "V-Meter" re-entry mode if the quick re-entry or charging station was not encountered.

Follow these instructions to install the "Recall":

- the "Recall" must be positioned at a distance of 4 and 10 m. (13.2 - 33') in front of the charging station;
- the "Recall" must be positioned at a distance of 2 m. (6.6') in front of any narrow passages;
- the "Recall" must be positioned in the section in front of the "Quick Re-entry".

NB: If the robot does not find the charging station within a certain amount of time, it will follow the perimeter wire in "Follow wire" mode.

SETUP OF THE ROBOT'S QUICK RE-ENTRY TO THE CHARGING STATION

Quick re-entry requires a special installation of the perimeter wire that allows the robot to reduce the re-entry path to the charging station. This special installation of the perimeter wire should only be used for gardens where quick re-entry significantly reduces the path and where the perimeter length is greater than 200 meters.

To setup the quick re-entry, position the perimeter wire on the ground so that it forms a triangle with one side of 50 cm (19.7 ") and the other two sides of 40 cm (15.75 ") each, as shown in the figure.

As the robot heads back to the charging station with the two wheels on either side of the wire, it intercepts this triangle and stops moving. It then turns approximately 90° towards the inside of the garden and starts moving in the new direction until running into the perimeter wire on the opposite side.

Arrange the wire for quick re-entry in a point where there is at least 200 cm (78.74 ") of straight wire in front of the station, and at least 150 cm (59.05 ") of straight wire behind it.

Do not set up the wire along the straight section immediately in front of the charging station or near any obstacles. Make sure there are no obstacles along the re-entry path that may obstruct the quick re-entry.

Do not set up the wire along excessive slope, so that the robot can recognize it easily. The maximum slope depends on the lawn conditions. It should remain under approximately 20%.



Important

An incorrect setup of the robot's quick re-entry may prevent the robot from returning to the charging station quickly. When the robot travels along the perimeter to reach a secondary area, it may not detect the quick re-entry setup.

The illustration provides some useful tips on how to correctly setup the robot for a quick re-entry.

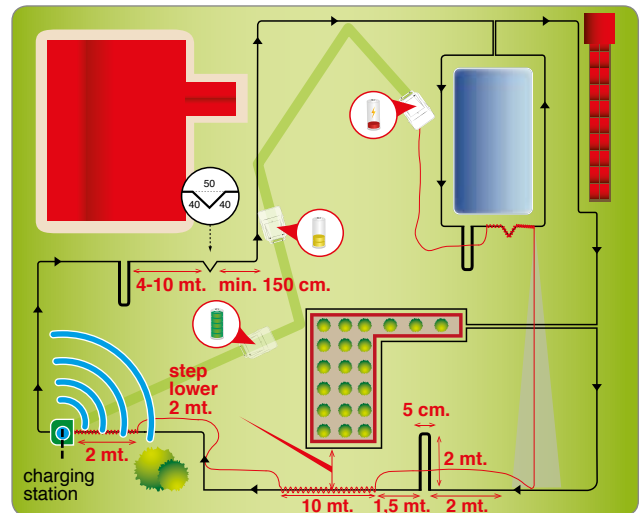

Preparation of the lawn to be mowed

1. Make sure the lawn to be mowed is even and does not contain holes, stones or other obstacles. If necessary, prepare the lawn by filling in any holes and removing any obstacles. If some obstacles cannot be removed, it is necessary to properly mark these areas with the perimeter wire.
2. The robot can mow surfaces inside the working area with a maximum slope of 45% (45 cm per meter in length) on a regular dry lawn, with no risk of wheels slipping, based on the accessories installed. In the other cases it is necessary to respect the 35% of the slope.

The perimeter wire must be laid on the ground sloping no more than 20% (20 cm per meter in length), being in mind that the robot requires greater grip during the return to the charging station. Therefore, it is necessary to check carefully the lawn conditions and to respect the limits. If the perimeter wire is laid on the sloping more than 20%, the robot may depart from it, to move more easily, not being able to overcome narrow passages and to recognize the quick re-entry set up.

The slope must not increase at least 35cm inside or outside the perimeter wire.

If these instructions should not be complied with, while the robot is working on sloping areas and detects the wire, its wheels could slip and make it leave the working area.

If there are any obstacles on slopes that are closed to the abovementioned limits, the ground must be uniformed for at least 35cm in the part uphill of the obstacle to reduce the slope.

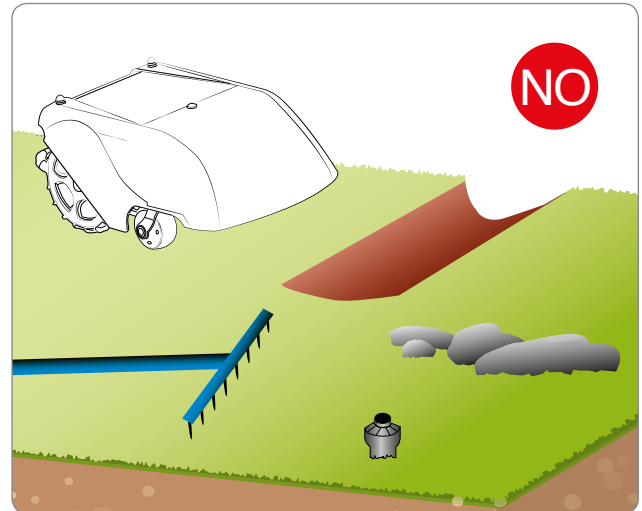

Important

Areas with slopes greater than those allowed cannot be mowed with the robot. Therefore, position the perimeter wire in front of the slope so that it is excluded from the area to mow.

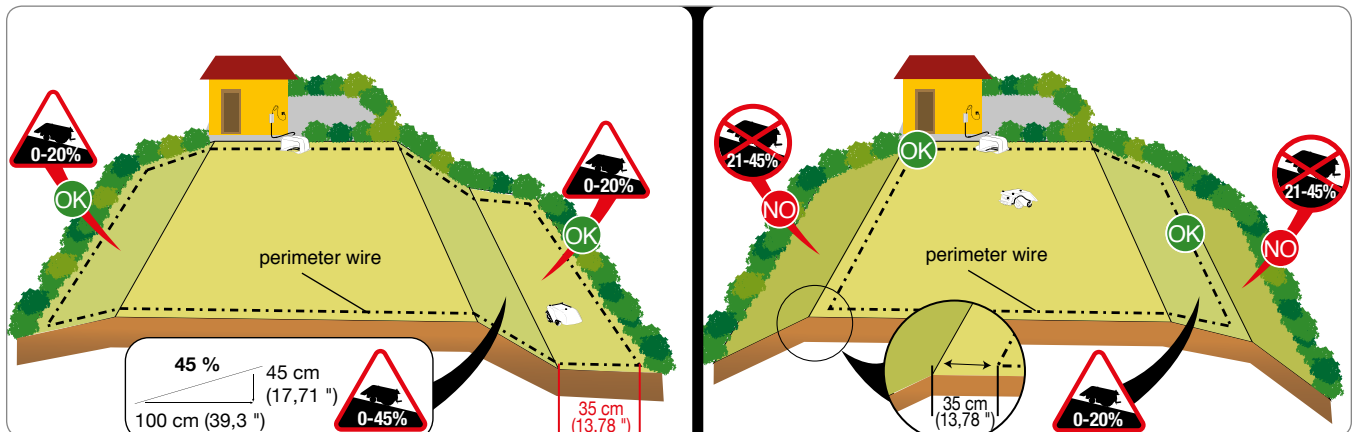

Marking the boundary of the work area

3. Check the entire lawn surface and assess whether it is necessary to divide it into separate work areas as per the rules described here below. Before installing the perimeter wire, check the entire path to make this procedure easier. The illustration shows a lawn with the track for installation of the perimeter wire.

During installation, identify any secondary areas and closed areas. A secondary area is part of a lawn connected to the primary lawn with a passage that is difficult to reach by the robot's normal movement. The area must be reachable without any rises or drops greater than those allowed. Whether a zone is to be defined a "secondary area" also depends on the size of the primary area. The larger the primary area, the harder it will be to reach narrow passages. More generally, a passage narrower than 200 cm (78.74 ") is considered a secondary area. The number of secondary areas managed depends on the characteristics of the model (See "Technical Specifications").

The minimum passage allowed is **70 cm** (27.56 ") from each edge of the perimeter wire. The perimeter wire must be positioned at a distance of (to be indicated below) from any objects outside the lawn; therefore, the necessary space for passing must be **140 cm** (55.12 ") if there is a wall or hedge on both sides.

If this passage is very long, the width should be more than **70 cm** (27.56 ") between perimeter wires.

During programming, it is necessary to configure the size of the secondary areas as a percentage of the lawn, and the quickest direction for reaching it (clockwise or counter-clockwise), as well as the number of meters of wire needed to reach the secondary area. See "Programming Mode."

If the aforesaid minimum requirements are not met i.e. an area separated by a rise or drop with characteristics that cannot be managed by the robot or a passage (corridor) narrower than **70 cm** (27.56 ") from perimeter edge to perimeter edge, then this area of the lawn is considered a "Closed Area." To mark a "Closed Area" lay the outgoing and incoming perimeter wire in the same track at a maximum distance of **1 cm** (0.40 "). In this case, the robot is unable to reach the area autonomously, and must be managed as described in the chapter "Management of Closed Areas." The management of "Closed Areas" reduces the square meters that can be managed autonomously by the robot.

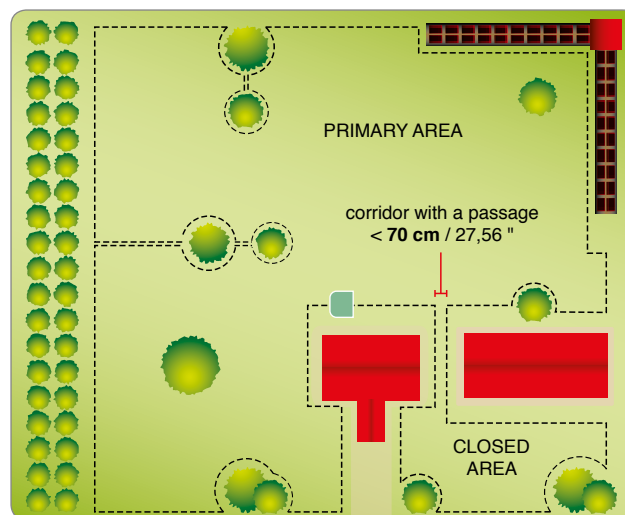
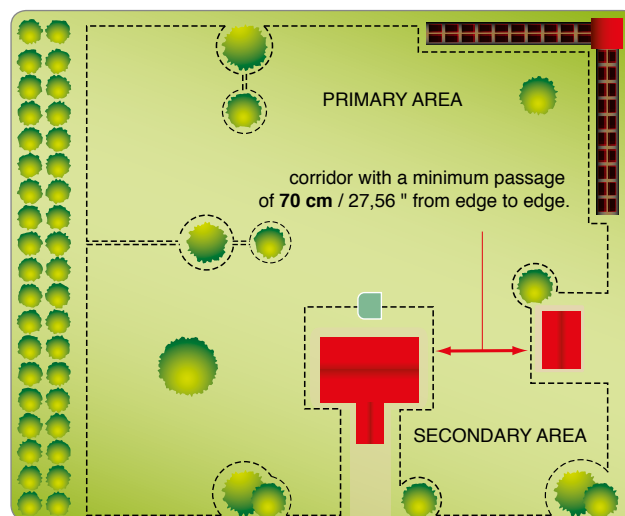
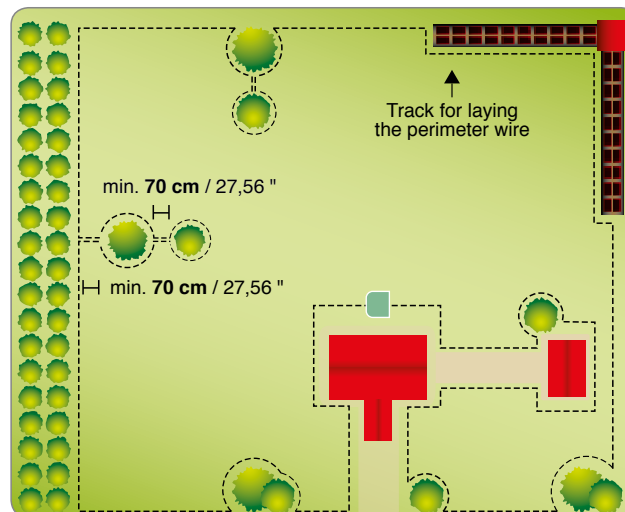

4. If there is a pavement or driveway inside or outside the work area, which is at the same level of the lawn, lay the perimeter wire at a distance of 5 cm (1.96 ") from the edge of the pavement. The robot will come out slightly from the lawn and all the grass will be mowed. If the pavement is made of metal or if there is a metal manhole cover, shower plate or electrical wires, lay the perimeter wire at least 30 cm (11.81 ") from the metal object in order to prevent malfunction of the robot and disturbances on the perimeter wire.

i Important

The illustration shows an example of the elements inside and on the perimeter of the work area and the distances to follow for the correct laying of the perimeter wire. Mark the boundary of elements in iron or other metals (drain covers, electric connections, etc.) to prevent any interferences to the signal of the perimeter wire.

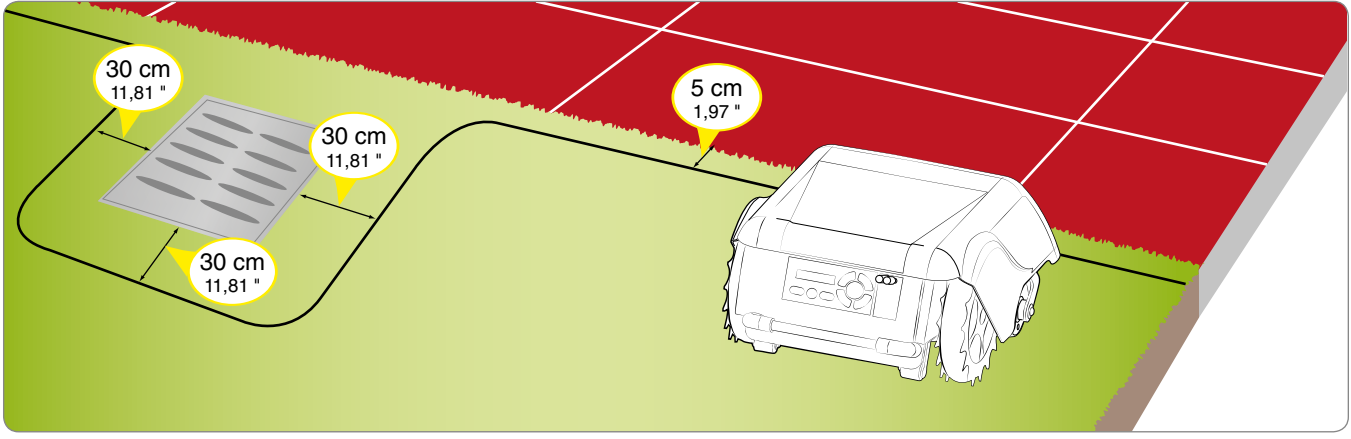

If an obstacle is present inside or outside the work area, such as a kerb or wall, lay the perimeter wire at least 35 cm (13.78 ") from the obstacle. Increase the distance between the perimeter wire and the obstacle by at least 40 cm (14.75 ") if you want to avoid the robot from bumping into the obstacle. Any grass close to the edge and outside the defined work area can be cut with a grass trimmer or brushcutter.

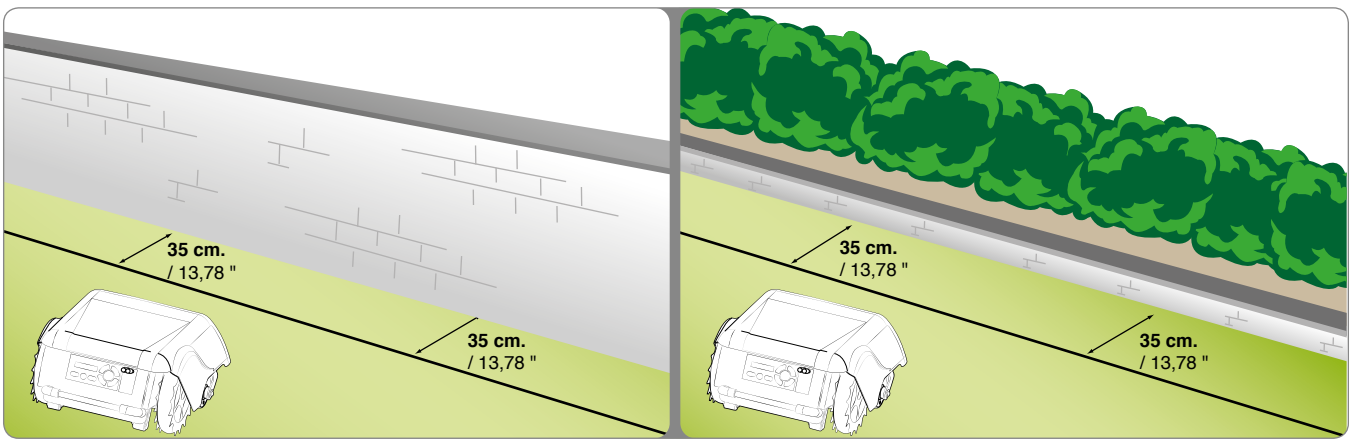

If a flower bed, hedge, plant with protruding roots, small ditch of 2-3 cm or small kerb of 2-3 cm is present inside or outside the work area, lay the perimeter wire at least 30 cm (11.81 ") from the obstacle to prevent damage being done to the robot or the obstacle. Any grass present inside the work area can be cut and finished with a grass trimmer or brushcutter.

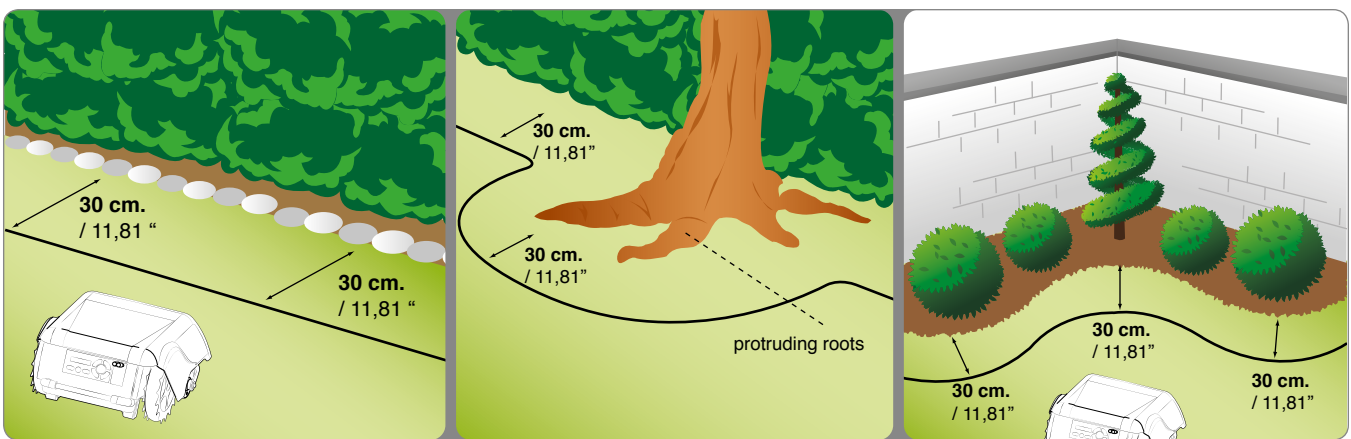

If there is a pool, pond, ravine, ditch, steps or public roads not protected by an easily crossable fence or wall inside or outside the work area, install the perimeter wire at least 90 cm (35.43 inches) from the edge. In order to install the perimeter wire as close as possible to the edge of the cutting area, we recommend installing a fence that is difficult to cross if adjacent to public areas, or a fence at least 15 cm high in other cases. This will allow laying the perimeter wire at the distances described in the previous paragraphs.

EN



Important

Carefully follow the distances and slopes specified in the booklet to guarantee excellent installation and proper functioning of the robot. Increase the distance by at least 30 cm (11.81 ") in the presence of slopes or slippery ground.

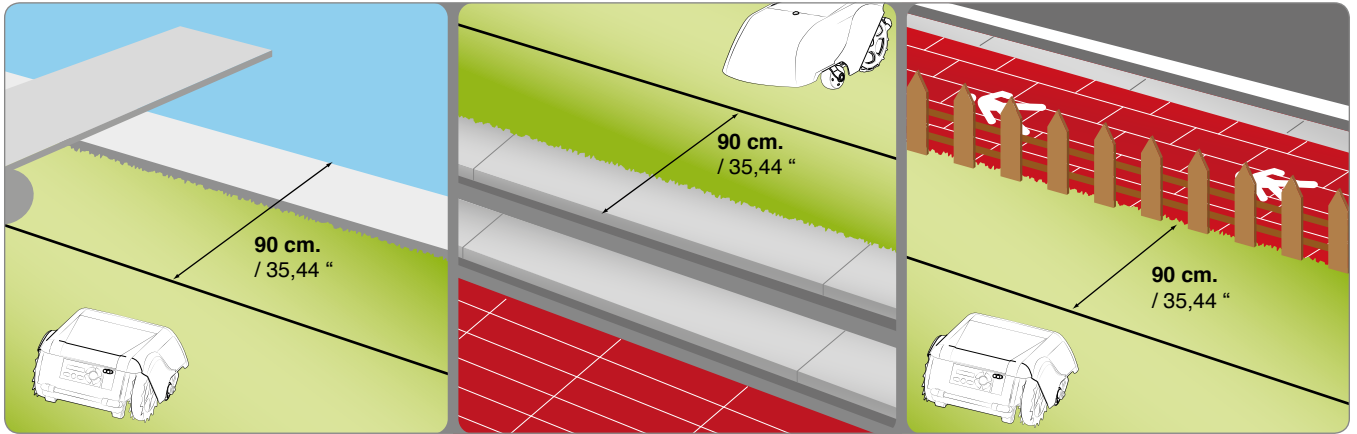

Obstacles resistant to knocks, such as trees, bushes or poles without sharp edges present inside the work area do not need to be delimited. The robot hits the obstacle and changes direction. If you don't want the robot to knock into the obstacles and for its safe and silent operation, all the fixed obstacles need to be delimited. Slightly sloping obstacles such as flower pots, stones or trees with protruding roots must be delimited to protect the cutting blade and the obstacles themselves.

To mark the boundary of the obstacle, start from the outside point of the perimeter nearest the object to delimit, arrange the perimeter wire so that it reaches the obstacle, goes around it and then travels back along the previous path, observing the regular distances described in the previous paragraphs. Overlap the outgoing wire and the incoming wire so that they pass under the same peg, this will allow the robot to go past the perimeter wire.

For the robot to function correctly, the minimum overlapping length should not be greater than 70 cm (27.56 ") in order to allow the robot to move regularly.

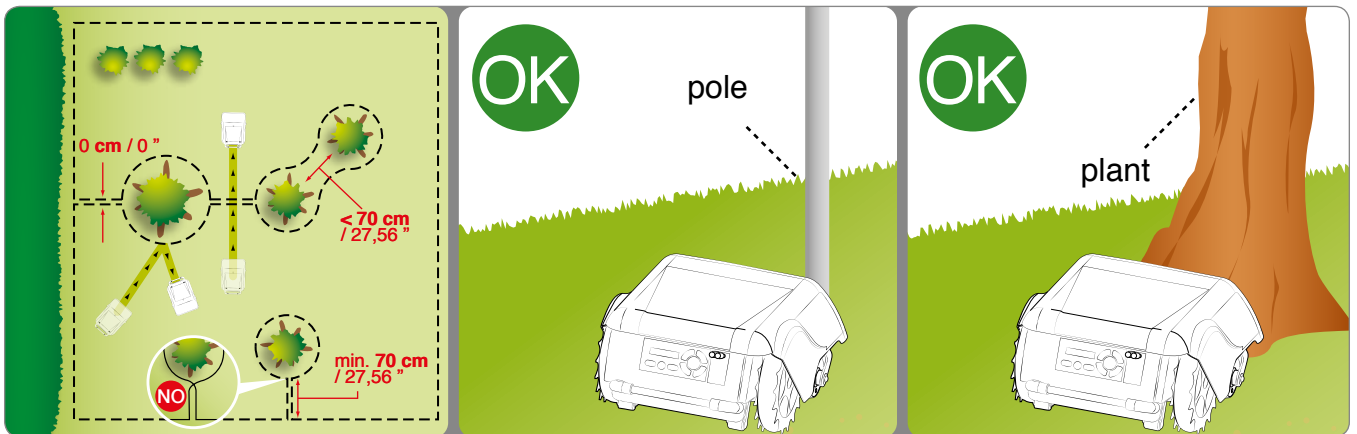

INSTALLATION OF PERIMETER WIRE

The perimeter wire can be buried or laid on the ground. If you have a wire layer machine, it is better to bury the wire for greater protection. Otherwise, install the wire on the ground with the pegs provided as described below.



Important

Start laying the perimeter wire from the area where the charging station is installed, leaving a couple of extra meters so that it can be cut down to size when connecting to the power unit during the final phase.

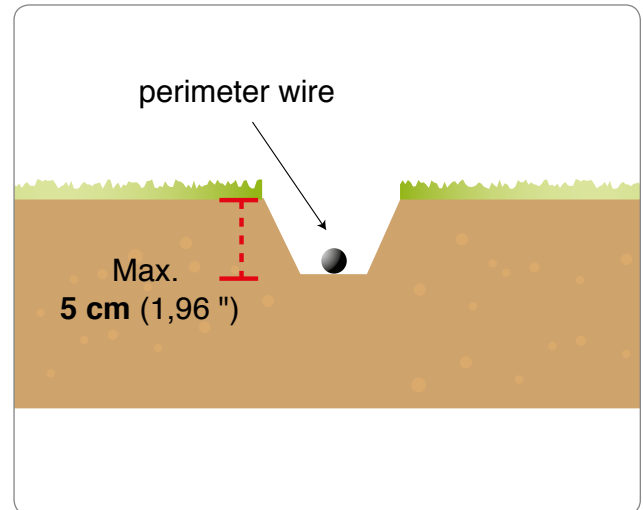

Ground wire

Cut the grass as low as possible with a grass trimmer or brushcutter along the entire path where the cable will be laid. This will make it easier to lay the cable in contact with the ground and reduce the risk of the robot damaging the insulation.

1. Position the wire in a clockwise direction along the entire path and secure it with the pegs supplied, making sure there is a maximum distance of around 100 cm (39.37 inches) between each peg. The wire must be in contact with the ground to prevent it from being damaged by the robot before the grass covers it.
 - When laying the perimeter wire, follow the installation direction around the flowerbeds, i.e. a counter-clockwise direction.
 - In curved sections, secure the wire so that it is not twisted, but curves nicely (radius of 20 cm).

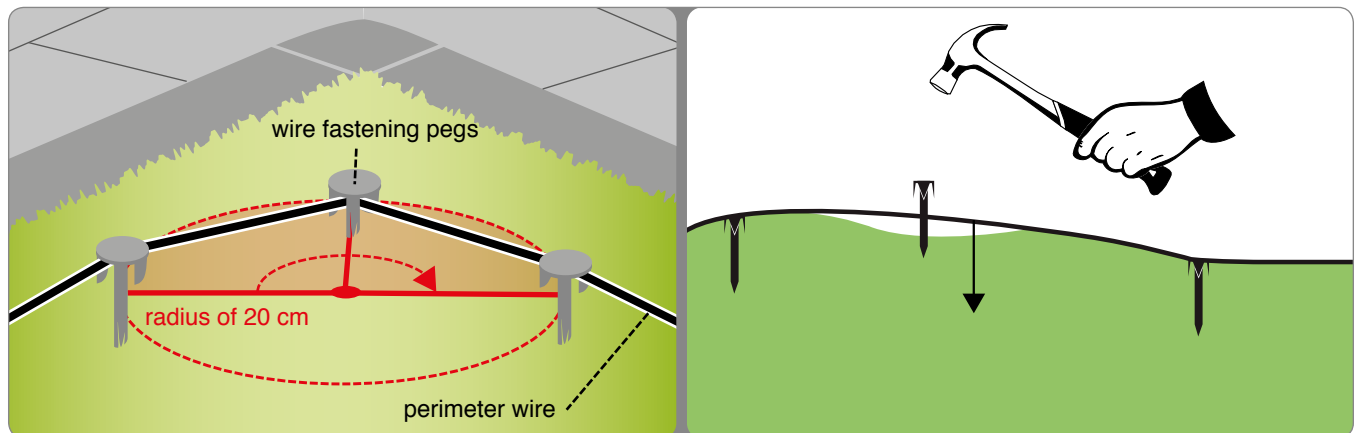
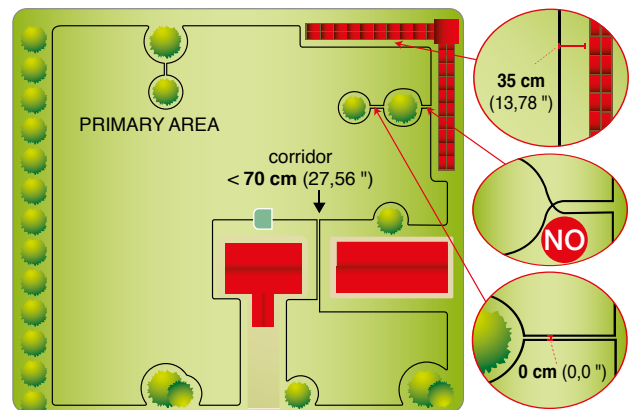

Buried wire

1. Dig an even furrow in the ground (approximately 2-3 cm or 0.787-1.181").
2. Position the wire in a clockwise direction along the track at a depth of a couple of centimetres. Do not bury the wire deeper than 5 cm, so as not to reduce the quality and intensity of the signal picked up by the robot.
3. During the laying of the wire, it may be necessary to secure it in some points with the pegs provided in order to hold it in place when covering with the ground.
4. Cover all the wire with soil and make sure it remains taut in the ground.

Joining of the perimeter wire

Use an original joint if another perimeter wire is needed to complete the installation.

Insert each end of the wire in the joint, making sure the wires are fully inserted so that the ends are visible on each side. Press the button on the upper side all the way down using a pair of pliers.



Important

- For a safe and secure electrical connection, only use original joints.
- Do not use insulating tape or other types of joints that do not provide proper isolation (lugs, terminals, etc.). After some time, soil moisture causes oxidation and interruption of the perimeter wire.

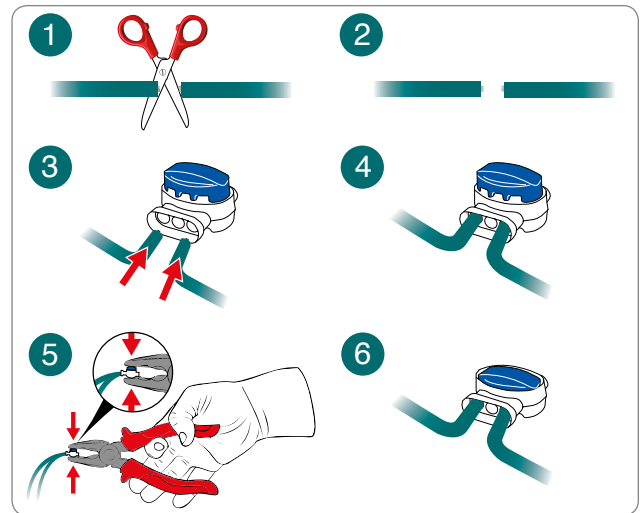

INSTALLATION OF THE CHARGING STATION AND POWER SUPPLY UNIT



Warning – Caution

Before carrying out any operations, disconnect the robot from the mains power.

Position the power supply unit in an area that cannot be reached by children. For example, at a height above 160 cm (63 ").

Do not shorten or lengthen the cable getting to the charging station, wrap as an 8 like form the excess cord, as shown in the figure.

The perimeter wire used for the installation cannot be less than 50m, contact the closest customer service centre .

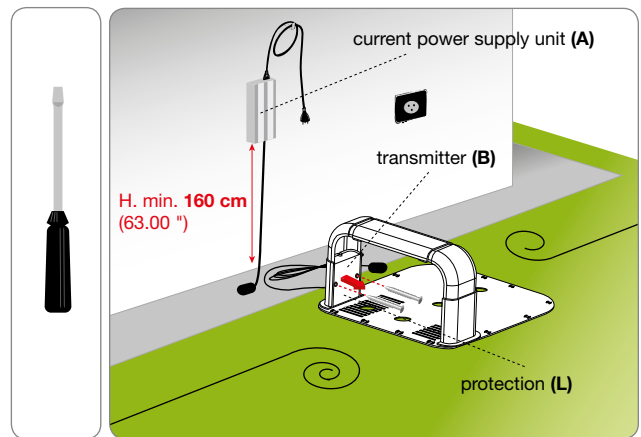

1. Remove the protection (L).
2. Position the charging station in the predefined area.
3. Insert the perimeter wire (M) along the guide in the charging station.
4. Connect the station incoming wire to red terminal of the transmitter (T). Connect the station outgoing wire to the black terminal.



The terminals are used only to connect the original perimeter wire.

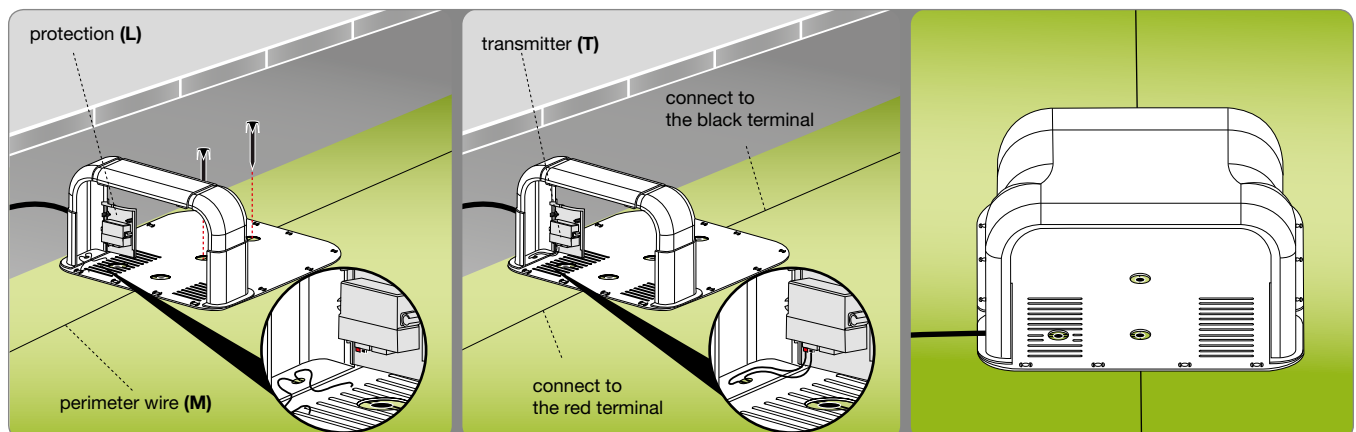

- Fasten the charging station (N) to the ground with the pegs (P). If necessary, secure the charging station with screw anchors (Q).

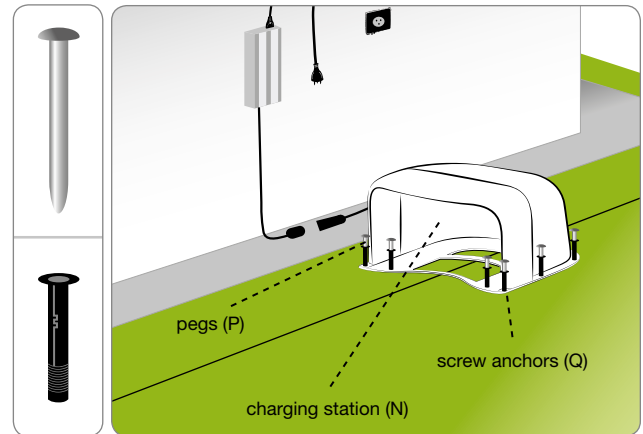

- Install the power supply unit (A).
- Connect the power cord (E) of the charging station (N) to the power supply unit (A).
- Connect the plug of the power supply unit (A) to the electrical outlet.
- If the LED of the transmitter flashes, the connection is correct. Otherwise, find the anomaly (see "Troubleshooting Guide").
- Replace the protection (L).

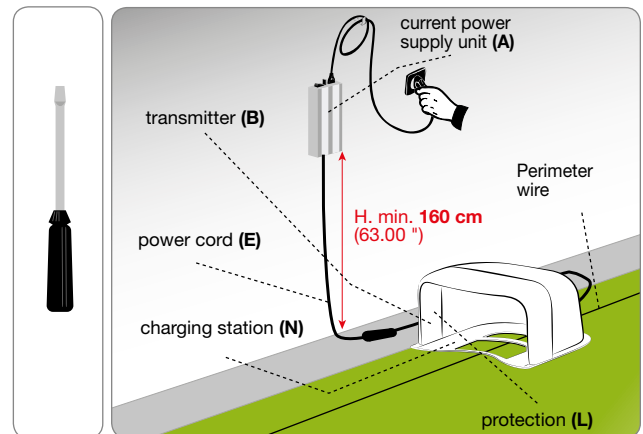

BATTERY CHARGING ON FIRST USE

- Place the robot inside the charging station.
- Press the ON key and wait a few seconds for the robot to turn on completely. Enter the password (if prompted) (See "Password Entry"). Press "Enter" if the information messages remain on the display.
- After a few seconds, the "CHARGING" message will appear on the display. Afterwards, the display will show other information in rotation such as:
 - day of the week, Date;
 - programmed working times;
 - working time, total working time;
 - battery information.
- Press the "PLAY/PAUSE" key. The "PAUSE" function appears on the display. The batteries start the charging cycle.
- At the end of charging, the robot can be programmed for initial start-up (see "Programming Mode").

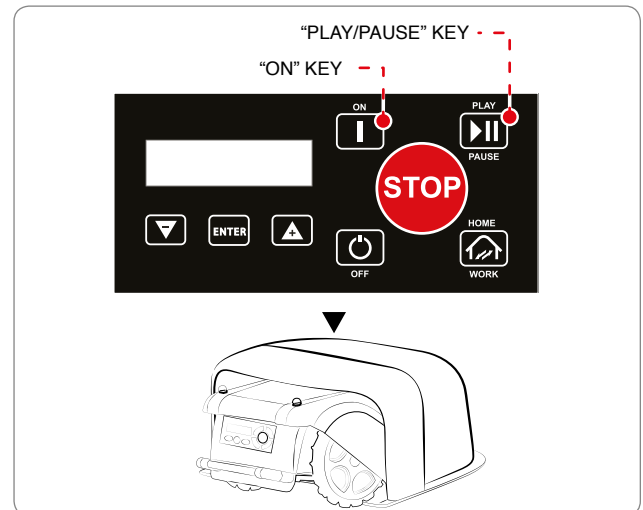

Important

On first use, always charge the batteries for at least 4 hours.

ADJUSTMENT RECOMMENDATIONS

EN



Important

The user must make any adjustments according to the procedures described in this manual. Do not make any adjustments which are not expressly indicated in this manual. Any special adjustments, not expressly indicated in this manual, must only be performed by personnel from the Manufacturer's authorised service centre.

ADJUSTMENT OF CUTTING HEIGHT

Before setting the cutting height of the blade, make sure the robot is safely off (see "Robot Safety Stop").



Important

Use protective gloves to prevent injuries to your hands.

1. Turn over the robot and position it so as not to ruin the hood.
2. Unscrew the screw (C).
3. Lift or lower the cutting unit (D) to set the desired cutting height. The value can be measured using the graduated scale.
4. Once the height has been set, fasten the screws (C). The higher the travel of the cutting unit (D), the lower the height of the lawn after mowing.



Important

Do not use the robot to mow grass which is 1 cm (0.40 ") higher than the cutting blade. Reduce the cutting height gradually. It is recommended to reduce the height by at least 1 cm (0.40 ") every 1-2 days until the ideal height is reached.

5. Turn the robot back over to its operating position.

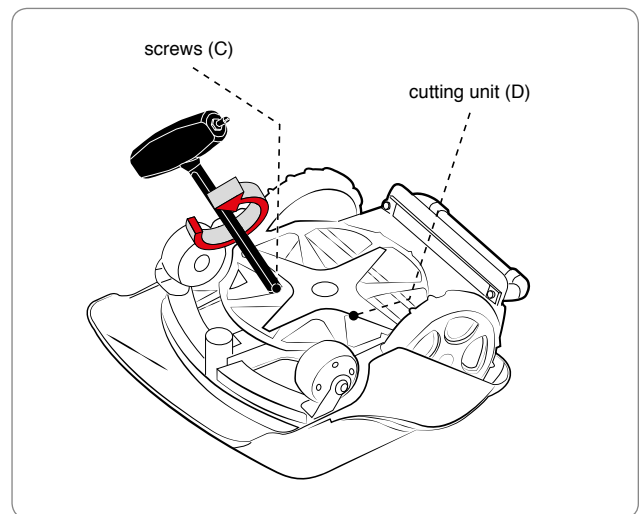



Important

- When using the robot for the first time, please read the manual carefully and make sure you have understood it completely; in particular, all the information on safety.
- The product must only be used for its intended purpose as described by the Manufacturer. Do not tamper with any device to obtain different operating performances.
- Avoid using the robot and its peripherals in bad weather conditions especially when there is a risk of lightning.

DESCRIPTION OF ROBOT COMMANDS

The illustration shows the position of the control functions on the machine.

- A. DISPLAY:** lights up to show all the functions.
- B. ON:** press to turn on the lawnmower.
- C. OFF:** press this key to stop the robot, the display turns off.
- D. PLAY/PAUSE:** press to stop the mower, leaving the display on "stand-by"; in this way, the mower can be programmed. Press again to restart the mower. If the key is pressed while the mower is charging, the mower does not resume working until it is pressed again and the word "PAUSE" disappears from the display.
- E. HOME/WORK:** press this key to allow the mower to return to its station and, consequently, to start recharging the batteries. If pressed while the robot is being charged, the robot interrupts the charging cycle and starts operating again.
- F. "+" KEY:** during operation, press this key to restart the blade which was previously stopped. During programming, press this key to increase the values shown in the menu.
- G. ENTER:** during operation, press this key to turn on the spiral function. During programming, press to confirm and memorise the selection.
- H. "-" KEY:** during operation, press to stop the blade. During programming, press to decrease the values shown in the menu.
- I. STOP:** press to stop the mower safely. Only use in case of imminent danger and to perform maintenance on the robot.

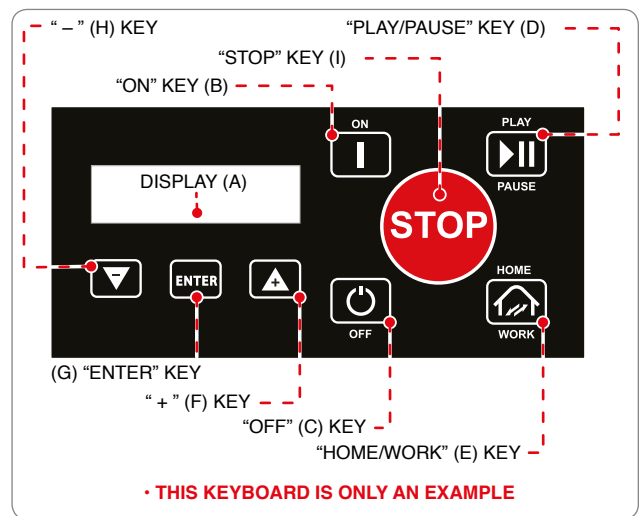

MENU ACCESS

The robot functions can be programmed via the different functions of each menu. The table reports the list of menus available with the relative functions.

To program the robot, proceed as follows:

1. Press the ON key and wait a few seconds for the robot to turn on completely. Enter the password (if prompted) (See "Password Entry"). Press "Enter" if the information messages remain on the display.
2. if the robot is turned on when inside the charging station, after a few seconds the message "CHARGING" appears on the display, then press the "PLAY/PAUSE" key;
3. the "PAUSE" function now appears on the display;
4. press the "ENTER" key. This allows entering into programming menu and the "SETTINGS" function appears on the display.

NAVIGATION

Follow these instructions to navigate through the programming menu:

- “+” and “-”: allows scrolling through the menu items in a cyclical manner or changing the value of the function displayed.
- “ENTER”: moves to the next menu level or confirms and memorises the value shown in the display and skips to the next function.
- “PLAY/PAUSE”: goes back to the previous menu level until exiting from the programming menu.
- “OFF”: turns off the robot without confirming the last function displayed.

The menu has a tree structure. Follow the introduction summarising the programming functions available. A detailed explanation of each function is found in the pages following the flow diagram.

Functions marked * are only available on some models. See "Technical Data" table.

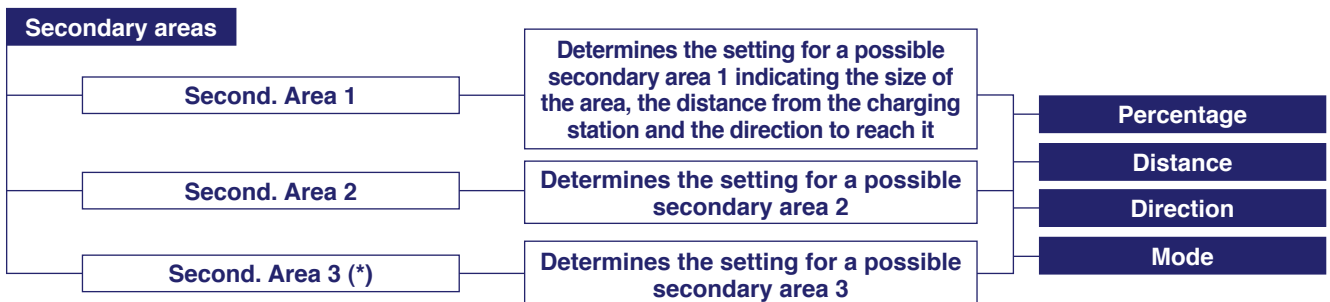
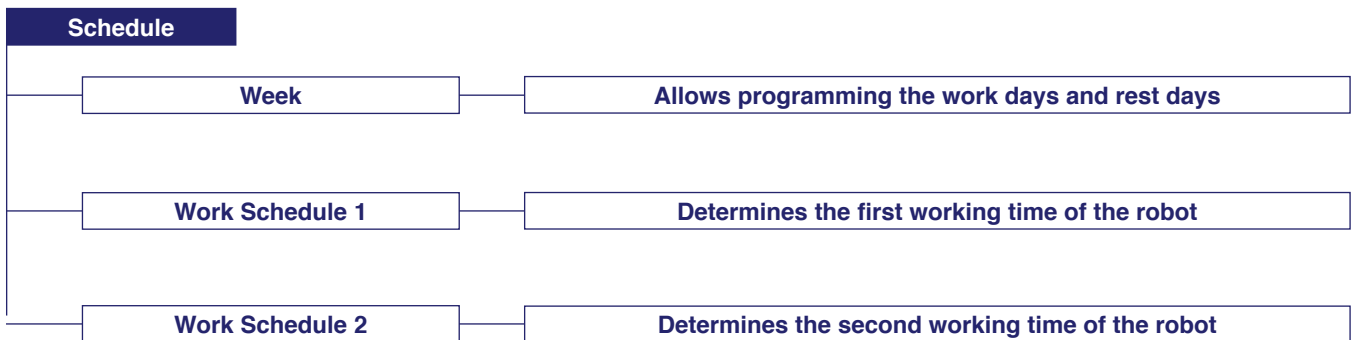
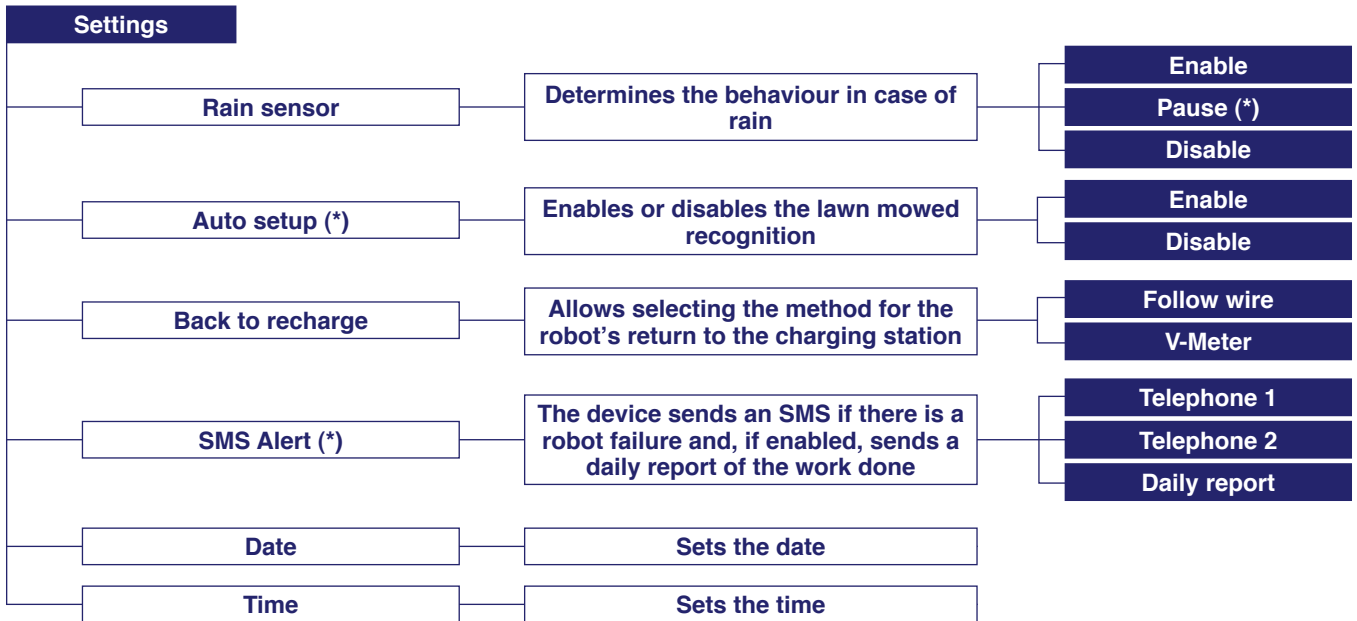

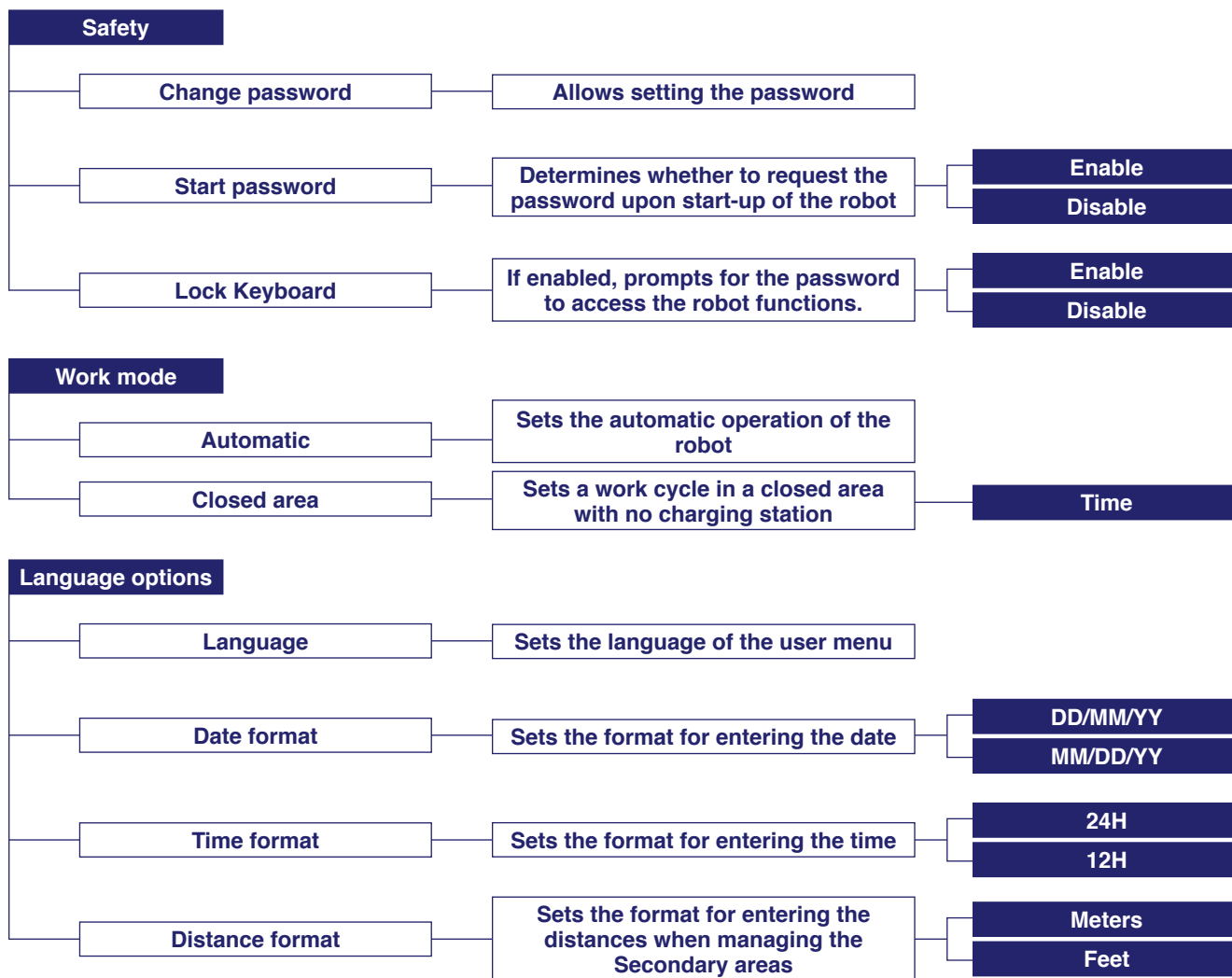

SETTINGS – PROGRAMMING MODE

RAIN SENSOR: Function for setting the robot in case of rain.

- **Enable:** in case of rain, the robot returns to the station and remains in “charging” mode. At the end of the charging cycle, the robot only starts mowing again if it has stopped raining.
- **Disable:** in case of rain, the robot continues to mow.
- **Pause:** in case of rain, the robot returns to the station and remains there (in “charging” mode) until the “PLAY/PAUSE” key is pressed.

AUTO SETUP: (only for some versions, see “Technical Specifications”), function for automatically reducing the robot’s mowing time based on the conditions of the lawn.

- **Enable:** the robot reduces the working time based on the conditions of the grass. When the lawn surface is mowed, the machine automatically sets a rest period which delays subsequent departures from the charging station. However, the robot will operate within the set working times.
- **Disable:** the robot will work according to the set time and until the batteries run out.

BACK TO RECHARGE: allows selecting the method for the robot’s return to the charging station.

1. **“Follow wire”.** The robot returns to the charging station by positioning the wheels on either side of the perimeter wire.
2. **“V-Meter”.** The robot runs along the perimeter wire at an indicative distance ranging from a few centimetres to one meter (3.2 '), touching it every now and again in the curved sections until it recognises the recall to the charging station. Refer to the “Installation” chapter.

SMS Alert: this accessory available only for some models. Contact the Manufacturer's Customer Service Centre or one of the authorised centres for checking minimum requirements. The device sends an SMS if there is a robot failure and, if enabled, sends a daily report of the work done.

- **Telephone 1:** set the telephone number where the message is to be sent.
- **Telephone 2:** set the telephone number where the message is to be sent.
- **Daily report:** enables or Disables the sending of a daily report with information on the work done.

DATE: function for setting the date.

TIME: function for setting time.

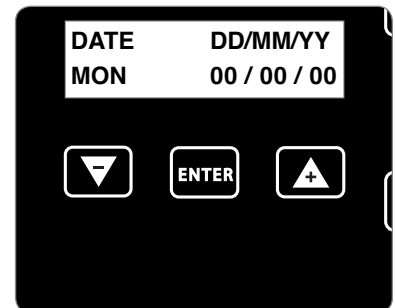
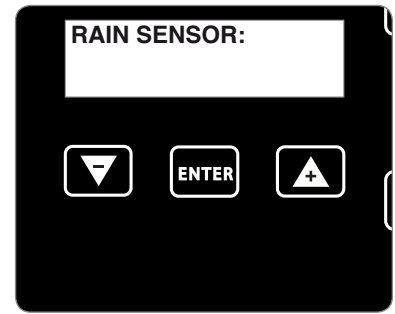

WORK SCHEDULES – PROGRAMMING MODE

WEEK: function for programming the operating days of the robot during the week. The cursor automatically positions itself under the letter “M” (**Monday**). Setting all the days at “1111111” means that the robot will work every day. Setting “0000000” means that the robot will not work on any day of the week.

- Value 1: robot’s work day.
- Value 0: robot’s rest day.
- Value B: robot’s working day. Before performing the work cycle, the robot mows the grass along the edge. It is recommended to leave the default frequency.

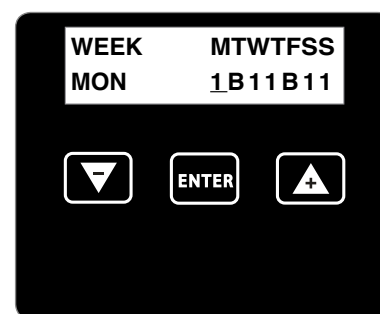

Important

To get the best out of the robot, it is recommended to program the robot to work every day.

WORK SCHEDULE 1: function for setting the first time of the robot’s working day. The cursor automatically positions itself in the area under the first time (e.g. 10:00am to 1:00pm). Set the time for the start and end of the work. Setting the time at “00:00 – 00:00” means that the robot will not work during Work Schedule 1. Once entered. If the entered time is wrong such as if the time overlaps with the working time 2 or if the starting time is after the end time, the robot beeps and resets the set value.



Important

If it is necessary to set secondary areas, then it is preferable to program both work schedules in order to increase the mowing frequency of the area.

The setting of the time is essential for the robot’s proper functioning. Many parameters influence the setting of the work schedules, such as the number of secondary areas, the number and the power of batteries of the robot, complexity of the lawn, type of grass, etc. Generally, the working hours must be increased slightly when mowing gardens with secondary areas, with lots of obstacles and complicated areas. Below is a table with the indicative times for configuring the robot on first use.

NB. Set all the weekdays at “1” – “Work Days.”

m ² (ft ²)	Time 1	Time 2
500 (5380)	10:00 12:00	
800 (8608)	10:00 11:30	16:00 17:30
1200 (12912)	10:00 12:00	16:00 18:30
2000 (21520)	09:00 12:00	16:00 19:00
2500 (26900)	09:00 19:00	
3000 (32280)	08:00 20:00	
3200 (34432)	08:00 21:00	

SECONDARY AREAS – PROGRAMMING MODE

If the area to be mowed includes secondary areas based on the definition given in the chapter “Preparation and Marking the Boundaries of the Work Areas”, then it is necessary to program the secondary areas so the robot knows how to reach them and how many times.

SECONDARY AREA: function for defining the automatic mowing of a secondary area.

- **Percentage:** allows setting the dimensions of the secondary area to be mowed in respect to entire lawn surface. Below is a table to use as a guide for configuring a secondary area:

- 10% indicates a very small area.
- 30% indicates an area which is approximately one third of the entire garden.
- 50% indicates an area which is approximately half of the entire garden.
- 80% indicates a secondary area which is bigger than the primary area.
- 100% the robot will follow the perimeter wire to mow the secondary area each time it exits the charging station.

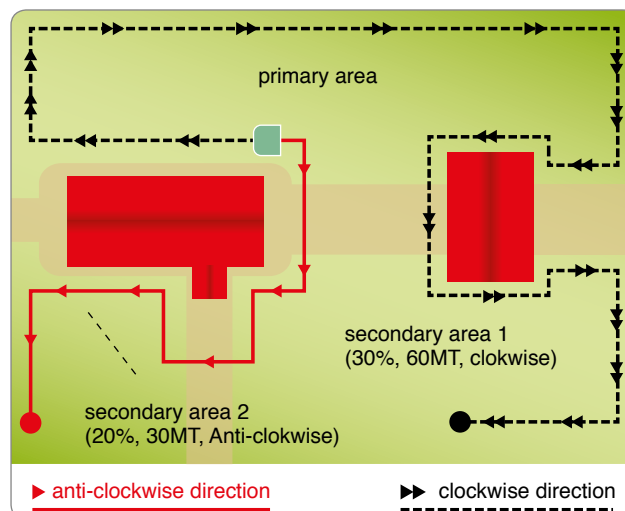

- **Distance:** this allows setting the distance necessary for the robot to reach the internal part of the secondary area following the perimeter wire. It is recommended to measure half the distance of the secondary area to ensure that the robot starts working inside that area.
- **Direction:** indicates the shortest direction for reaching the secondary area. The direction can be clockwise or counter-clockwise. The robot exits from the charging station and follows the wire in the indicated direction to reach the secondary area.
- **Mode:** indicates the method for reaching the secondary area. Use the “Follow wire” method when there are lots of obstacles in the garden close to the perimeter wire (less than 2 m) or when there are tight areas to pass through (less than 2 m) to reach the secondary areas. In all other cases use the “V-Meter” method.
 - “**Follow wire**”. The robot reaches the secondary area positioning its wheels astride the perimeter wire.
 - “**V-Meter**”. The robot reaches the secondary area running along the perimeter wire at an indicative distance from a few cm to 1 m (3.2 ')).

SECONDARY AREA 2: function for defining the automatic mowing of secondary area number 2. This setting uses the same configuration parameters as those used for secondary area 1.

SECONDARY AREA 3: (only for some versions, see “Technical Specifications”). Function for defining the automatic mowing of secondary area number 3. This setting uses the same configuration parameters as those used for secondary area 1.

SAFETY – PROGRAMMING MODE

CHANGE PASSWORD: function for setting or changing the password.

- **No:** the password entered does not need to be changed.
- **Yes:** for entering or changing the password which will be used to start the robot. You will be prompted to enter the following information:
 - password: enter the old password (manufacturer’s default 0000).
 - new password: enter the new password.
 - repeat password: enter the new password again.



Important

To set or change the password, it is first necessary to enter the previous one and then enter the new one. Upon purchase, the password entered by the manufacturer consists of four numbers (0000).



Important

When entering the password, you will be prompted to re-enter the password in order to ensure that it has been set correctly. In order to not forget the password, choose a number combination that is easy to remember.

START PASSWORD: this function allows defining whether you want to enter a password each time the robot is turned on after a period of inactivity (e.g. winter storage).

- **No:** there is no need to enter a password each time the robot is turned on. The robot requires the password to confirm this parameter.
- **Yes:** the password will be required each time the robot is started.

OPERATING MODE – PROGRAMMING MODE

Function for setting the operating mode of the robot. The robot automatically returns to “AUTOMATIC” mode when turned off.

- **Automatic:** normal operating mode. The robot recognises the perimeter wire and returns to the charging station whenever necessary.
- **Closed area:** operating mode in closed areas with no charging station. For the correct use of this mode, refer to “USE OF ROBOT IN CLOSED AREAS WITH NO CHARGING STATION.”

LANGUAGE OPTIONS – PROGRAMMING MODE

LANGUAGE: function for selecting the language to use for the messages and user menu. Scroll through the various options with the “+” or “-” key and confirm with “ENTER”.

- DATE FORMAT
- TIME FORMAT
- DISTANCE FORMAT

These functions allow personalising the date, time and distance formats.

INITIAL START UP – AUTOMATIC MODE

The automatic cycle is started during the initial start-up or after a period of inactivity.

1. Check that the height of the lawn surface to mow is compatible with the proper functioning of the robot (see “Technical Specifications”).
2. Adjust the cutting height as desired (see “Adjustment of Cutting Height”).
3. Check that the work area has been correctly marked and that there are no impediments to the regular functioning of the robot as indicated in the section “Preparation and Marking the Boundaries of the Work Areas” and following sections.
4. Position the robot inside the charging station.
5. Press the ON key and wait a few seconds for the robot to turn on completely. Enter the password (if prompted) (See “Password Entry”). Press “Enter” if the information messages remain on the display.
6. If starting the robot for the first time, it is necessary to program the settings. However, if starting the robot after a long period of inactivity, check that the programmed functions correspond to the actual condition of the lawn to be mowed (e.g. addition of a pool, plants, etc.) (See “Programming Mode”).
7. After a few seconds, the message “CHARGING” will appear on the display.
8. The robot starts to mow the lawn according to the modes programmed.
9. Check there are no large puddles after a heavy rain, otherwise the area must be put in order or make sure the robot is in “Pause”.

ROBOT SAFETY STOP

During use, it may be necessary to stop the robot. In normal conditions, the robot can be stopped with the "OFF" key. In case of danger or when performing any maintenance, it is necessary to stop the robot in safe conditions in order to prevent the blade from accidentally starting. Press the "STOP" key to stop the robot. Disconnect the power plug from the electrical outlet.



Important

The robot safety stop is necessary during maintenance and repairs (for example, blade replacement, cleaning operations, etc.).

To start, proceed as indicated:

- position the robot inside the cutting area;
- press the ON key and wait a few seconds for the robot to turn on completely. Enter the password (if prompted) (See "Password Entry"). Press "Enter" if the information messages remain on the display. The display will light up, "Pause" is indicated shortly after, the robot is now in the pause state;
- press the "PLAY/PAUSE" key.

If the robot is started up outside of the cutting area, the blade motor will not start and after briefly searching for the signal, the robot will show "OUT OF BORDER" on the display. Press "OFF", position the robot inside the cutting area and carry out the start up procedure again.

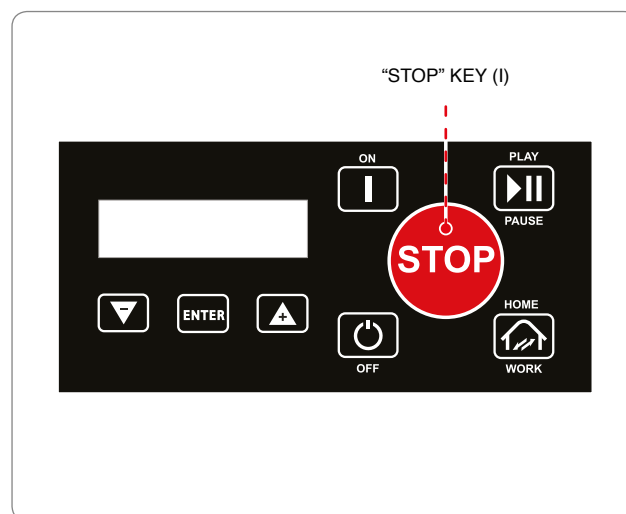

AUTOMATIC RETURN TO THE CHARGING STATION

The robot stops the work cycle if the following conditions are verified.

- **End of working time:** at the end of the working time, the robot automatically returns to the charging station and starts operating again according to what has been programmed (see "Programming Mode").
- **Rain:** with the function active, the robot returns to the recharging station automatically and will start working again as programmed (see "Programming mode").
- **Battery to be charged:** the robot automatically returns to the charging station.
- **Lawn mowed (only for some versions, see "Technical Specifications):** if the sensor detects that the lawn has already been mowed, it automatically returns to the charging station and starts operating again according to what has been programmed (see "Programming Mode").

USE OF THE ROBOT IN CLOSED AREAS WITH NO CHARGING STATION

The start-up of the robot in "closed area" mode is for mowing closed areas which are delimited by the perimeter wire and which have no charging station.



Warning – Caution

Carry the robot using the handle provided. Do not grab the robot by the body and always use the handle provided.

Position the robot inside the work area at a minimum distance of 100 cm (39.37 ") from the perimeter wire and from any other obstacle.

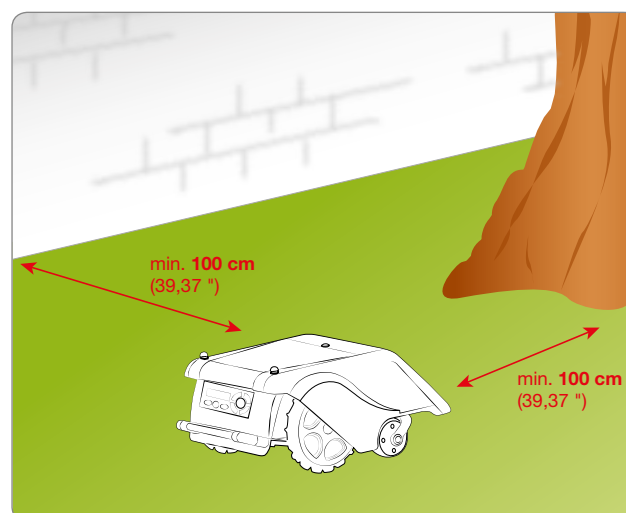

1. Press the ON key and wait a few seconds for the robot to turn on completely. Enter the password (if prompted) (See "Password Entry"). Press "Enter" if the information messages remain on the display.
2. The "PAUSE" function appears on the display.
3. Enter into programming mode and select "WORK MODE". Select "CLOSED AREA" and the words "CLOSED AREA – 60 Min" (default value) will appear on the display.
4. Press either the "+" or "-" key to set the minutes.
5. Press "ENTER" to confirm.
6. Press the "PLAY/PAUSE" key to exit the programming menu and then restart the robot. After the set time, the robot safely stops next to the perimeter wire.
7. Restore the normal functioning of the robot as described in chapter "INITIAL START UP – AUTOMATIC MODE".

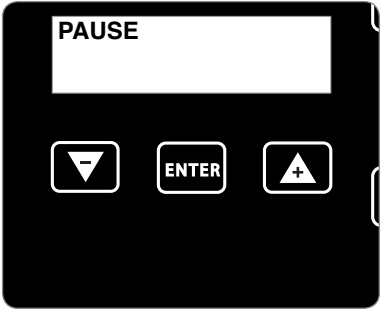

PASSWORD ENTRY

The robot can be protected by a password consisting of four numbers which can be enabled, disabled and personalised by the user (see "Programming Mode").

1. On the display appears the message:
2. Press either the "+" or "-" key to set the first number.
3. Press "ENTER" to confirm. The cursor moves to the next position.
4. Repeat the procedure to set all the numbers of the password.

The robot is now ready for use.

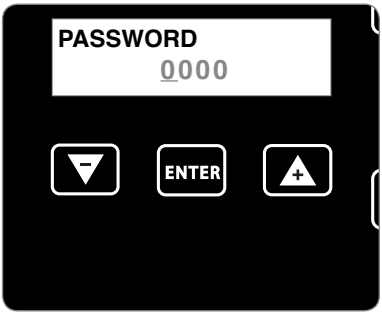

VISUALISING THE DISPLAY DURING THE WORK PHASE

While in operation, the following data appears on the display of the robot:

- speed of mower;
- cutting blade speed;
- percentage of battery charge.

While the robot is charging, the word "CHARGING" appears on the display.

If the robot is outside the working time, the display shows the day and time of the next scheduled start.

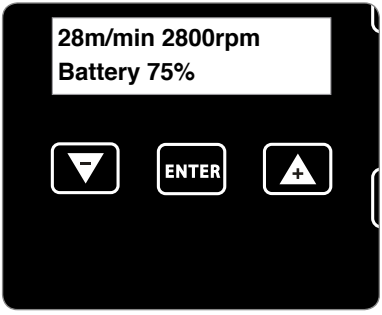

PROLONGED INACTIVITY AND RESTARTING

After a long period of inactivity of the robot and before the mowing season, it is necessary to perform a series of operations to guarantee the correct functioning at the time of reuse.

1. Fully charge the battery before winter storage. Recharge the battery at least once every five months.
2. Have the routine maintenance performed by an authorised dealer. This is essential for keeping the robot in good condition. The assistance service usually includes the following operations:
 - total cleaning of the robot, the cutting blade and all the other moving parts;
 - cleaning of the inside of the robot;
 - checking of robot functioning;
 - checking and, if necessary, replacement of any worn parts such as the cutting blade, the brushes (only in robots equipped with brushed motors);
 - checking of the battery capacity;
 - if necessary, the dealer may also load new software.
3. Accurately clean the robot and charging station (see “Robot Cleaning”)
4. Check any worn or damaged components such as the cutting blade and evaluate their replacement.
5. Store the robot in a protected and dry place with an ambient temperature between 10° and 20° C, out of reach of foreign elements (children, animals, other foreign objects, etc.). Store the robot at a temperature below 20°C in order to reduce the automatic discharge of the batteries.
6. Disconnect the power plug (A) from the electrical outlet.
7. Cover the charging station (C) to prevent any foreign materials from getting inside (leaves, paper, etc.) and for preserving the contact plates.

Restarting

Before restarting the robot after a long period of inactivity, proceed as follows:

1. connect the power plug (A) to the electrical outlet;
2. reconnect the main electrical power supply;
3. position the robot inside the charging station;
4. Press the ON key and wait a few seconds for the robot to turn on completely. Enter the password (if prompted) (See “Password Entry”). Press “Enter” if the information messages remain on the display;
5. after a few seconds, the message “CHARGING” will appear on the display;
6. the robot is now ready to be used (see “Programming Mode”).

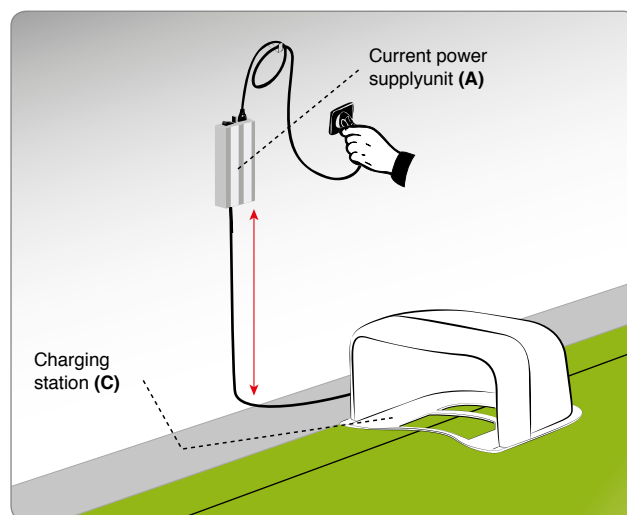



Danger - Attention

Do not recharge the robot in explosive and flammable environments.

1. supply electricity to the charging station and make sure the plates are clean;
2. position the robot inside the charging station;
3. Press the ON key and wait a few seconds for the robot to turn on completely. Enter the password (if prompted) (See "Password Entry"). Press "Enter" if the information messages remain on the display.
4. after a few seconds, the message "charging" will appear on the display;
5. press the "play/pause" key (b). the batteries start the charging cycle;
6. at the end of the charging cycle (approx. 6 hours), press the "off" key (c);
7. store the robot in a protected and dry place with an ambient temperature between 10° and 20° c, difficult to reach by children, animals, other foreign objects, etc.

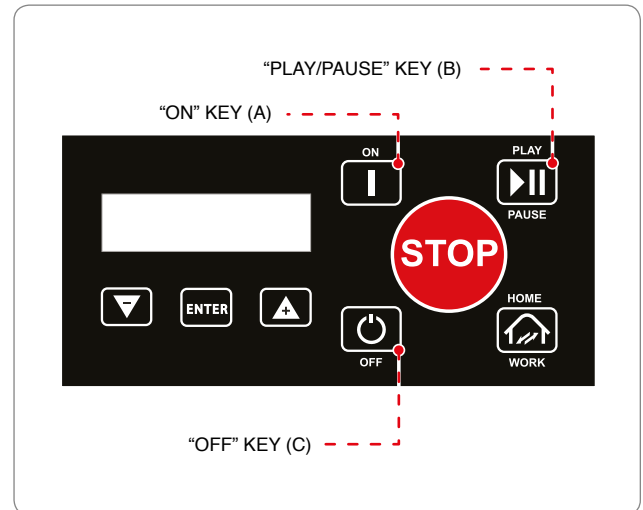

OPERATING TIPS

Below are some useful operating tips to follow when using the robot:

- even after being suitably informed on the use of the robot, it is always a good idea to simulate some test manoeuvres on first use to identify the commands and main functions;
- check and secure the fastening screws of the main components;
- mow the lawn frequently to avoid excessive growth of the grass;
- do not use the robot to mow grass which is 1 cm (0.40 ") higher than the cutting blade. In case of high grass, lift the cutting blade and then lower it gradually on the following days;
- if the lawn is equipped with an automatic sprinkler system, program the robot to return to the charging system at least one hour before the sprinklers are turned on;
- check the slope of the ground and make sure the maximum values allowed are not exceeded in order to prevent damage to the robot and the sprinklers;
- it is recommended to program the robot so that it does not work more than is necessary, also taking into consideration the different growth rates of the grass in different seasons, so as not to subject it to unnecessary deterioration and reduction of the battery life;
- when using the robot, make sure the work area is clear of people (in particular, children, the elderly or disabled people) and pets in order to prevent safety risks. To minimise the chance of injury, program the robot so that it operates at suitable times of the day.

ROUTINE MAINTENANCE

MAINTENANCE RECOMMENDATIONS



Important

During maintenance, use personal protection equipment indicated by the Manufacturer, especially when working on the blade. Before carrying out any type of maintenance, make sure the robot is turned off (see "Robot Safety Stop").

SCHEDULED MAINTENANCE TABLE

Frequency	Part	Type of maintenance	Reference
Weekly	Blade	Clean and check the efficiency of the blade. If the blade is bent or very worn, replace it	See "Robot Cleaning" See "Blade Replacement"
	Battery charging knobs	Clean and remove any rust	See "Robot Cleaning"
	Contact plates	Clean and remove any rust	See "Robot Cleaning"
	Rain sensor	Clean and remove any rust	See "Robot Cleaning"
Monthly	Robot	Clean the robot	See "Robot Cleaning"
Once a year and at the end of the mowing season	Robot	Have the robot serviced at an authorised service centre	See "Prolonged inactivity and restarting"

ROBOT CLEANING

1. Stop the robot safely (see “Robot Safety Stop”).



Warning – Caution

Use protective gloves to prevent cutting your hands.

2. Clean all the outside surfaces of the robot with a sponge soaked in warm water and a mild detergent. Squeeze well to remove any excess water before use.



Warning – Caution

The use of too much water may cause water to penetrate into the device which could damage the electrical parts.

3. Do not use solvents or benzene so as not to damage the painted surfaces and plastic components.
4. Do not wash the inside parts of the robot and do not use jets of pressurised water so as not to damage the electric and electronic parts.



Warning – Caution

In order to avoid irreversible damage to the electric and electronic components, do not immerse the robot, partially or completely, in water because it is not watertight.

5. Check the lower part of the robot (cutting blade area, and wheels), use a brush suitable to remove deposits and/or residuals that may impede the proper functioning of the robot.
6. Remove any grass and leaves from the gripping areas of the robot.
7. Clean the knobs of the battery charger (A), the contact plates (B) and remove any deposits or residuals caused by electric contacts with a dry cloth and, if necessary, with fine sandpaper.
8. Clean the rain sensor (C) and remove any dirt or rust.
9. Clean the inside of the charging station to remove any accumulated residuals.

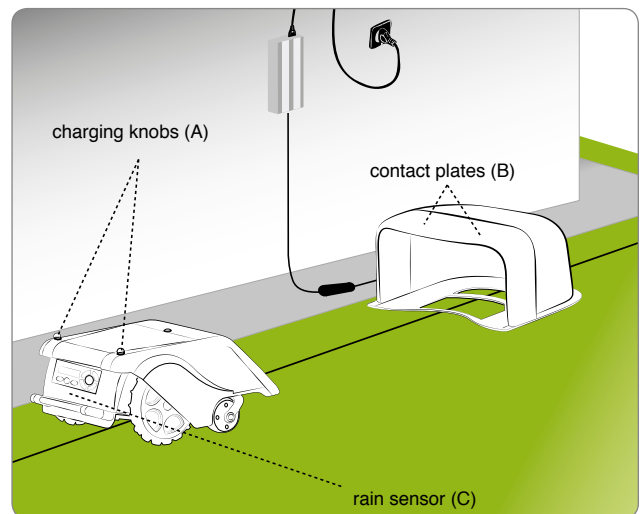

TROUBLESHOOTING GUIDE

EN

The information below is designed to help identify and correct any faults and/or malfunctions which may occur during operation. Some faults can be fixed by the user, while others require specific technical skills or special expertise and therefore must only be fixed by qualified personnel with certified experience in the specific field of intervention.



Warning – Caution

Safely stop the robot (see “Robot Safety Stop”) in case it is necessary to check the robot, in order to avoid danger of accidental blade starting.

Problem	Cause	Remedies
The robot is very noisy	Cutting blade damaged	Replace the blade with a new one (see “Blade Replacement”)
	Cutting blade clogged by residuals (tape, cords, plastic fragments, etc.)	Safely stop the robot (see “Robot Safety Stop”). Unclog the blade <div style="display: flex; align-items: center;"> <div style="background-color: #800000; color: white; padding: 2px 5px; font-weight: bold;">Warning – Caution</div> </div> <p>Use protective gloves to prevent injuries to your hands</p>
	The robot was started in the presence of obstacles (fallen branches, forgotten objects, etc.)	Stop the robot safely (see “Robot Safety Stop”) Remove the obstacle and restart the robot (see “Start up - Automatic mode”)
	Electric motor failure	Have the motor replaced or repaired by your nearest authorised service centre
	Grass too high	Increase the cutting height (see “Adjustment of cutting height”) Carry out a preliminary cutting of the area with a normal lawnmower
The robot does not position itself correctly inside the charging station	Incorrect positioning of the perimeter wire or power cord of the charging station	Check the connection of the charging station (see “Installation of charging station and power supply unit”)
	Collapsing of ground next to the charging station	Position the charging station on a flat and stable surface (see “Planning of system installation”)
The robot does not behave correctly around the flowerbeds	Perimeter wire laid incorrectly	Reposition the perimeter wire correctly (counter-clockwise direction) (see “Installation of perimeter wire”)
The robot works at the wrong time	Clock was set incorrectly	Reset the clock of the robot (see “Programming Mode”)
	Working time was set incorrectly	Reset the working time (see “Programming Mode”)
The robot does not execute quick re-entry	Quick re-entry not setup correctly	Check the exact layout of the quick re-entry (see “Layout of the robot’s quick re-entry to the charging station”)

Problem	Cause	Remedies
The work area is not completely mowed	Not enough work hours	Extend the working time (see "Programming Mode")
	Cutting blade clogged with deposits and/or residuals	Stop the robot safely (see "Robot Safety Stop")  Warning – Caution Use protective gloves to prevent injuries to your hands. Clean the cutting blade
	Cutting blade worn out	Replace the blade with an original spare part (see "Blade replacement")
	Work area too big compared to the actual capacity of the robot	Adjust the work area (see "Technical specifications")
	The batteries are about to run out.	Replace the batteries with original spare parts (see "Battery replacement")
	The batteries do not charge completely	Clean and remove any rust from the contact points of the batteries (see "Robot Cleaning"). Recharge the batteries for at least 12 hours
Secondary area not completely mowed	Programming error	Correctly program the secondary area (see "Programming Mode")
"Service" appears on the display	The robot needs to be serviced	Contact your nearest authorised service centre
"Lift" appears on the display	The robot is lifted from the ground	Check that the robot is not blocked or obstructed by any objects. Clean and eliminate any residual grass under the body shell which may obstruct the sensors (see "Robot cleaning")
"No Signal" appears on the display	The perimeter wire is not connected correctly (broken cable, no electrical connection, etc.)	Check the functioning of the electrical power supply, the correct connection of the power supply unit and of the charging station (see "Installation of charging station and power supply unit")
"Out of border" appears on the display	Too much slope	Delimit the area with too much slope (see "Planning of system installation")
	Perimeter wire laid incorrectly	Check that the wire has been installed correctly (too deep, next to metallic objects, distance between the wire marking the two elements less than 70 cm, etc.) (see "Planning of system installation")
	Perimeter wire marking the boundary of the inside areas (flowerbeds, bushes, etc.) laid in a counter-clockwise direction	Reposition the perimeter wire correctly (counter-clockwise direction) (see "Installation of perimeter wire")
	Overheated power supply unit	Adopt the appropriate measures to reduce the temperature of the power supply unit (ventilate or modify the installation area, etc.) (see "Planning of system installation")
	Incorrect wheel transmission	Check and, if necessary, correctly fasten the wheels

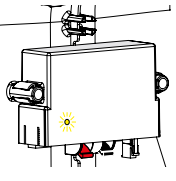
Problem		Cause	Remedies
“Wheel error” appears on the display		Ground is uneven or contains obstacles that prevent movement	Make sure the lawn to be mowed is even and does not contain holes, stones or other obstacles. Otherwise, fill in any holes and remove any obstacles (see “Preparation and marking the boundaries of the work areas (primary and secondary areas)”)
		Failure of one or both motors that operate the transmission of the wheels	Have the motor replaced or repaired by your nearest authorised service centre
“Too high grass” or “Blade Error” appears on the display		Cutting blade damaged	Replace the blade with a new one (see “Blade Replacement”)
		Cutting blade clogged by residuals (tape, cords, plastic fragments, etc.)	Stop the robot safely (see “Robot Safety Stop”) <div style="display: flex; align-items: center; margin-top: 5px;">  <div style="background-color: red; color: white; padding: 2px 5px; margin-left: 5px;">Warning – Caution</div> </div> <p>Use protective gloves to prevent injuries to your hands</p> <p>Unclog the blade</p>
		The robot was started in the presence of obstacles (fallen branches, forgotten objects, etc.)	Stop the robot safely (see “Robot Safety Stop”) Remove the obstacles and restart the robot (see “Start up - Automatic mode”)
		Electric motor failure	Have the motor replaced or repaired by your nearest authorised service centre
		Grass too high	Increase the cutting height (see “Adjustment of Cutting Height”). Perform a preliminary cutting of the area with a normal lawnmower
“WatchdogError” appears on the display		The internal “software safety” system is enabled	Turn the robot off and on. If the problem persists, contact your nearest authorised service centre
“Tilt” appears on the display		The robot is located on a slope that is higher than the allowed limits	Mark off the area that is too steep
	The led (c) does not turn on	No power supply	Make sure the power supply unit is correctly connected to the power outlet
		Interrupted fuse	Have the fuse replaced by your nearest authorised service centre
	The transmitter LED (C) is on	Interrupted perimeter wire	Stop the robot safely (see “Robot Safety Stop”). Disconnect the power plug from the power supply unit. Join the perimeter wire

RECOMMENDATIONS FOR REPLACING PARTS



Important

Replace and repair any parts according to the manufacturer's instructions, or contact the service centre if these operations are not included in the manual.

BATTERY REPLACEMENT



Important

Replace the batteries at an authorised service centre.

BLADE REPLACEMENT

1. Stop the robot safely (see "Robot Safety Stop").



Important

Use protective gloves to prevent injuries to your hands.

For replacement, use only the original blade suitable for the device.

MODEL: 7200BA0, 7200DE0, 7200EL0

Cutting blade code: CS_D0112_02

2. Turn the robot over and position it so as not to ruin the covering hood.
3. Unscrew the screws (B) to remove the blade (A).
4. Insert a new blade and fasten the screws.
5. Turn the robot back over to its operating position.

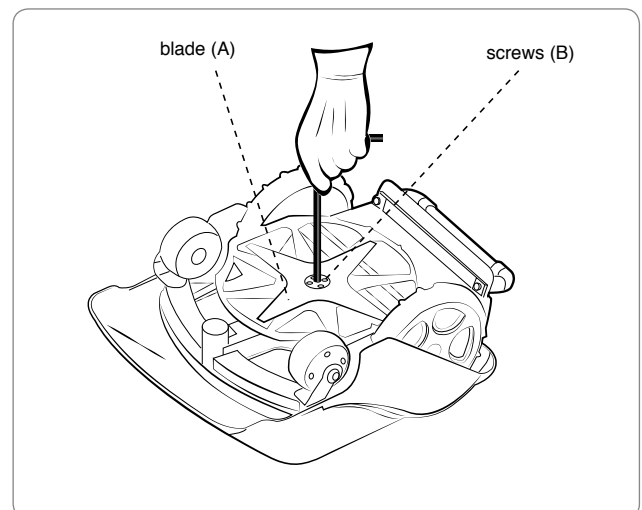

ROBOT DISPOSAL

- At the end of its useful lifespan, this product is classified as WEEE (waste electrical and electronic equipment). It must therefore not be disposed of as normal domestic waste, as mixed urban waste (undifferentiated) or as separated urban waste (differentiated).
- When it is time for disposal, the user must make sure that the product is recycled in compliance with the requirements of the local laws; in particular, electric and electronic components must be separated and sorted in authorised waste disposal centres for WEEE, or the product must be taken intact to the dealer when a new purchase is made. Abusive disposal of WEEE is punished by fines established by laws in force in the areas where said disposal occurs.
- Dangerous substances contained in electric and electronic equipment have potentially harmful effects on the environment and people's health so the user has a fundamental role in contributing to reuse, recycling and any other way of recovering WEEE.
- All parts, to be specifically separated and disposed of, are marked..



Danger - Attention

WEEE - Waste Electric and Electronic Equipment (WEEE) can contain dangerous substances with potentially harmful effects on the environment and people's health. WEEE must be disposed of correctly and only in specific disposal centres.

- Packaging - Product packaging is made with recyclable materials and must be disposed of in a sustainable manner in special disposal containers or authorised waste disposal centres.
- Batteries - Old or exhausted batteries contain harmful substances for the environment and people's health so must not be disposed of as normal domestic waste. The user must dispose of batteries in a sustainable way, in specific disposal containers or in authorised waste disposal centres.

ZUCCHETTI Centro Sistemi S.p.A. Via Lungarno 305/A Terranuova B.ni (AR) ITALY

declares and assumes liability that the product:

battery-powered automatic lawnmower robot, model 7200BA0, 7200DE0, 7200EL0, complies with the basic requisites for safety, health and environmental protection provided for by the following European Union directives:

Machinery directive 2006/42/EC, electromagnetic compatibility directive 2014/30/UE, RoHS directive 2011/65/EC, WEEE directive 2012/19/EU, directive for noise emission in the environment 2005/88/EC;

complies with the following harmonised standards:

- CEI EN 50338:2007-06 (**safety**) (for applicable parts);
- CEI EN 60335-1:2013-01 and EN 60730-1:2011 (**safety**);
- CEI EN 55014-1:2008-01+A1:2010-10+A2:2012-02 (**emission**);
- CEI EN 61000-3-2:2007-04 +A1,A2:2011-09 and CEI EN 61000-3-3:2009-09 (**emission**);
- CEI EN 55014-2:1998-10+A1:2002-08+A2:2009-08 (**immunity**);
- CEI EN 61000-4-2:2011-04 and CEI EN 61000-4-4:2006-01+A1:2010-09 and CEI EN 61000-4-5:2007-10 and CEI EN 61000-4-6:2011-10 and CEI EN 61000-4-11:2006-02 (**immunity**);
- CEI EN 60529:1997-07+A1:2000-06 (**protection rating of casings**);
- EN 50419:2006 (WEEE - Equipment marking);

complies with the following harmonised standards:

- EN 50636-2-107:2015 (**Special standards for battery-powered lawnmower robots**);
- IEC 61508-3:2010 (**Software functional safety**);

also declares that, pursuant to directive 2005/88/EC, the LWA sound power level, out of a significant sample is 74.0 dB ± 0.7 dB (weighted on A curve and referred to 1 pW), that the guaranteed LWA sound power level is less than 75 dB (weighted on A curve and referred to 1 pW) and that the technical folders in compliance with directives 2005/88/EC and 2006/42/EC are available c/o Zucchetti Centro Sistemi S.p.A. via Lungarno 305/a, Terranuova B.ni (ar), Italy.

Terranuova B.ni 01/10/2016
 Bernini Fabrizio
 (CEO)





AMBROGIO
ROBOT

USER'S MANUAL



Zucchetti Centro Sistemi SpA
Via Lungarno, 305/A
52028 - Terranuova B.ni (Ar) - Italy
Phone +39 055 91971
Fax +39 055 9197515



Ambrogio Robot



www.ambrogiorobot.com