

# TABLE OF CONTENTS

EN

<b>General information</b> .....	<b>2</b>
Purpose of the manual.....	2
Identification of manufacturer and equipment.....	3
<b>Safety information</b> .....	<b>3</b>
Safety regulations.....	3
Safety devices.....	4
Safety signals.....	5
<b>Technical information</b> .....	<b>6</b>
Technical specifications.....	6
General description of the appliance.....	7
Main parts.....	8
<b>Installation</b> .....	<b>9</b>
Packing and unpacking.....	9
Planning of system installation.....	9
Setting up of the perimeter wire.....	11
Re-entry method to the charging station.....	11
Setup of the robot's quick re-entry to the charging station.....	12
Preparation and marking the boundaries of the work areas.....	13
Installation of perimeter wire.....	17
Installation of the charging station and power supply unit.....	18
Battery charging on first use.....	20
<b>Adjustments</b> .....	<b>20</b>
Adjustment recommendations.....	20
Adjustment of cutting height.....	20
<b>Use and operation</b> .....	<b>21</b>
Requirements for use.....	21
Description of control panel and menu overview.....	21
Set up.....	22
Use of the robot in closed areas with no charging station.....	23
Access to the menu via app.....	23
Setting the user menu via the mobile application.....	23
Menu settings – programming mode.....	24
Robot safety stop.....	27
Prolonged inactivity and restarting.....	27
Battery charging after prolonged inactivity.....	28
Operating tips.....	29
<b>Routine maintenance</b> .....	<b>29</b>
Maintenance recommendations.....	29
Scheduled maintenance table.....	29
Robot cleaning.....	30
Troubleshooting.....	31
<b>Troubleshooting guide</b> .....	<b>31</b>
<b>Part replacement</b> .....	<b>33</b>
Recommendations for replacing parts.....	33
Battery replacement.....	33
Blade replacement.....	33
Robot disposal.....	34
<b>EC declaration of conformity</b> .....	<b>35</b>
<b>Warranty rules</b> .....	<b>36</b>
Conditions and limitations.....	36
How to request warranty service.....	36
Additional definitions.....	36

Reproduction, even partial, of this document without written permission by the manufacturer is strictly forbidden. The manufacturer assumes a policy of continual improvement and reserves the right to modify this document without prior notice on condition that the changes do not constitute health and safety risks.  
© 2008 – Text, illustrations and page layout by Tipolito La Zecca. The text may be reproduced, in whole or in part, on condition that the author is mentioned.

### PURPOSE OF THE MANUAL

- This manual forms an integral part of the appliance and was produced by the Manufacturer to provide the necessary information to people authorised to interact with it during its working life.
- Operators of the appliance must adopt correct working practices and must carefully read and follow all the instructions contained in this manual.
- This information is original and supplied by the manufacturer.
- Carefully read the instructions contained in this manual to avoid any unnecessary risks to people's health and safety, as well as economic damages.
- Keep this manual in a safe and easily accessible place for quick reference.
- Some information and illustrations contained in this manual may not perfectly correspond with the appliance in your possession; however, this does not affect its functioning.
- The Manufacturer reserves the right to make changes without any obligation to provide prior notice.
- The following symbols are used throughout this manual to highlight some particularly important information or to identify some important specifications.



#### **Danger - Attention**

**This symbol indicates situations involving imminent danger, which, if ignored, could put people's health and safety at risk.**



#### **Warning – Caution**

**This symbol indicates situations where it is necessary to behave in a certain way in order to avoid putting people's health and safety at risk, and to protect the device.**



#### **Important**

**This symbol identifies particularly important technical information which must not be ignored.**

## IDENTIFICATION OF MANUFACTURER AND EQUIPMENT

The nameplate shown here is applied directly onto the appliance. It contains references and all the information essential for safely operating the device.

For any technical requirements, please contact the Manufacturer's Technical Service Centre or an authorised dealer.

For technical assistance, please indicate the data reported on the identification plate, the approximate hours of use and the type of fault detected.

- A. Name of manufacturer.
- B. CE conformity label.
- C. Model and Version / serial number / manufacturing year.
- D. Technical data: voltage, current, protection rating, mass, cutting width.

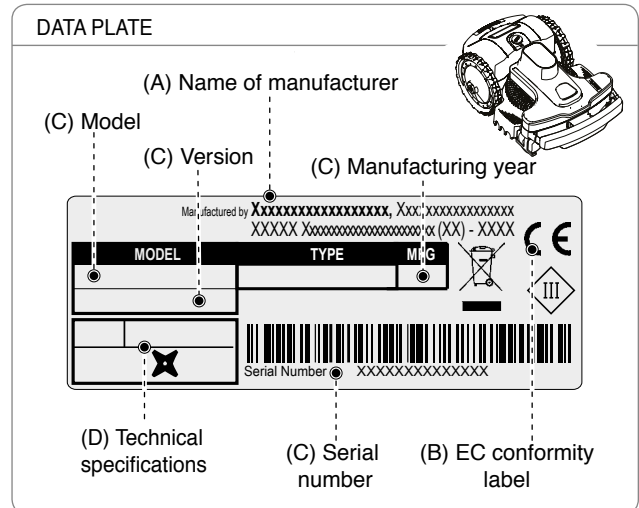

## SAFETY INFORMATION

The manufacturer carefully considered the possible hazards and personal risks that may result from interacting with the equipment. The purpose of this information is to inform users on the need to use extreme caution in order to avoid risks.



### SAFETY REGULATIONS



### THIS PRODUCT COMES WITH A BLADE AND IS NOT A TOY!

- Please read the manual carefully, especially the safety instructions, and make sure you understand them fully before using the product. Only use the equipment for the purposes specifically intended by the manufacturer. Carefully follow the instructions on operation, maintenance and repair.
- When using the robot, make sure there is no one in the working area, in particular children, the elderly or disabled and pets. Otherwise, program the robot to operate during hours when there is no one in this area. Keep an eye on the robot if you know that pets, children or other people are in the area. If a person or animal is found on the robot's path, stop it immediately.
- In working areas not bounded by a fence that can not be easily climbed over, supervise the device during the operation.
- Warning signs shall be placed around the working area of the robotic lawnmower if it is used in public areas. The signs shall have the following text: "**Warning! Automatic lawnmower! Keep away from the machine! Supervise children!**"
- This robot is not suitable for use by children and people with reduced physical, sensory or mental capabilities or inexperienced people who are not familiar with the product, unless they are supervised by a person responsible for their safety or have received instructions on how to use the appliance. Children should be supervised to ensure that they do not play with the appliance.
- Do not allow the robot to be used by people who do not know how it works.
- Operators who perform maintenance and repair work must be fully conversant with its special features and safety regulations. Before using the robot, carefully read the operating manual and make sure you understand the instructions.
- Never remove, bypass or tamper with the safety devices installed. The Manufacturer shall not be held liable if non-original spare parts are used. Failure to comply with this requirement may seriously endanger the health and safety of people.

- Check that there are no toys, tools, branches, clothing or other objects on the lawn which can damage the blades. Any objects on the lawn can also damage or prevent the correct functioning of the robot.
- Never allow people to sit on the robot. Never lift the robot to inspect the blade or to carry it while it is running. Do not place hands and feet under the robot when it is in operation.
- Do not use the robot when a sprinkler system is running. In this case, program the robot and the sprinkler system so that they do not operate at the same time. Do not wash the robot with high-pressure water jets and do not immerse it in water, partially or completely, as it is not watertight.
- Disconnect the power supply and activate the safety device before performing any adjustment or maintenance that the user is authorised to perform. Use the personal protection devices recommended by the Manufacturer, in particular, always wear protective gloves when handling the cutting blade.
- Cleaning and maintenance must not be performed by unsupervised children.
- Do not use the robot when the cutting blade is damaged. Replace the cutting blade.
- Do not use the robot with damaged external parts. If the mechanical parts of the robot are damaged, replace them.
- Do not use the robot if the power cord of the transformer is damaged. A damaged cord can lead to contact with live parts. To avoid any risk, have the cord replaced by the manufacturer or by its technical service centre or by a person with similar qualifications.
- If the power cord is damaged during use, press "STOP" to stop the robot and disconnect the power cord from the electrical socket.
- Visually check the robot regularly to make sure the blade, mounting screws and cutting mechanism are not worn or damaged. Make sure that all the nuts, bolts and screws are tightened to ensure that the robot is in good working condition.
- If the robot starts to vibrate abnormally during use, press "STOP" and disconnect the power cord from the electrical socket.
- Never use and recharge the robot in explosive and/or flammable environments.
- Only use the battery charger and power supply unit supplied by the manufacturer. Improper use may cause electric shocks, overheating or leakage of corrosive liquids from the battery. If any liquid leaks, wash the battery with water/neutraliser; in case of contact with eyes, seek medical attention.

---

## SAFETY DEVICES

---

### 1. Obstacle detector

The bumper sensor is activated if the robot strikes a solid object greater than 10 cm (3.94 ") in height, which stops the movement in that direction and moves backwards to avoid the obstacle.

### 2. Inclinometer

If the robot works on a slope which is steeper than the maximum limit, or tips over, the robot will stop the cutting blade.

### 3. Emergency stop switch

Located on the upper part of the robot with the word "STOP" larger than the other commands on the keypad. Pressing this button at any time during operation will immediately stop the movement of the lawnmower robot and the rotation of the blade will stop.

### 4. Over-current protection







Each motor (blade and wheels) is monitored continuously during operation for any situation that may cause them to overheat. If this occurs in the wheel motor, the robot will attempt to move in the opposite direction. If the over-current persists, the robot will stop and signal an error. If the cutting blade motor overheats, there are two intervention ranges. If the parameters fall within the first range, the robot will perform the manoeuvres to unblock the cutting blade. If the over-current is below the protection range, the robot will stop and signal a motor error.

### 5. No signal sensor

If there is no signal, the robot will automatically stop.

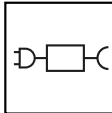

## SAFETY SIGNALS

	<p>Read user instructions carefully to understand meanings before using the machine.</p>		<p>Keep an adequate safe distance from the machine while it is running.</p> <p>While the robot is working, make sure there are no people in the working area (especially children, elderly or disabled people) and pets. Keep children, pets and other people at a safe distance when the machine is functioning. To prevent that risk, we advise scheduling the robot's mowing activities at suitable times.</p>
	<p>Do not touch the rotary blade and do not place your hands or feet underneath the machine when it is running. Wait until the blade and rotating parts come to a complete stop before accessing.</p>	 	<p>Warning! Do not spray water on the machine to clean or wash it.</p> <p>While the robot is working, make sure there are no people in the working area (especially children, elderly or disabled people) and pets. Keep children, pets and other people at a safe distance when the machine is functioning. To prevent that risk, we advise scheduling the robot's mowing activities at suitable times.</p>
	<p>Do not ride on the machine.</p>		<p>Use the robot only with the power supplies indicated in the "Technical Data" of the "Technical Information" chapter.</p>

# TECHNICAL INFORMATION

## TECHNICAL SPECIFICATIONS

Description		Model		
		8040BA0 B040BAH	8040BA0 B040BAH	8040BA0 B040BAH
Power KIT		2.9Ah - 2A LIGHT	5.8Ah - 5A MEDIUM	8.7Ah - 8A PREMIUM
Maximum recommended surface that can be mowed				
Working capacity ( -20%(*))	m <sup>2</sup> (ft <sup>2</sup> )	<b>800</b> (8608)	<b>1200</b> (12912)	<b>1800</b> (19368)
<b>Features</b>				
Dimensions (W x H x D)	mm	Model 8040BA0 : <b>635x464x300</b> Model B040BAH : <b>695x470x330</b>		
Robot weight (incl. battery)	kg	15,0	15,3	15,6
Cutting height (Min-Max)	mm (")	Model 8040BA0 : <b>20 - 65 (0,78-2,56 ")</b> Model B040BAH : <b>70 - 95 (2,75-3,74 ")</b>		
Diameter of blade	mm (")	<b>250 (9,84 ")</b>		
Motors		without brushes		
Cutting blade speed	RPM	3000 maintenance		
Ground speed	<b>Metres / Minute</b>	<b>30 ( 97,7 ")</b>		
Maximum recommended slope managed (*)	%	45% allowable, based on the lawn conditions and accessories installed. 35% maximum managed and recommended in conditions of a trimmed lawn. 20% in proximity of the outside edge or perimeter wire.		
Ambient operating temperature	Max °C	<b>ROBOT: -10°(14 F.) (Min) +50° (122 F.) (Max)</b> <b>CHARGING STATION: -10°(14 F.) (Min) +45° (113 F.) (Max)</b> <b>BATTERY CHARGER: -10°(14 F.) (Min) +40° (104 F.) (Max)</b>		
Measured sound power level	dB(A)	63		
Water protection class	IP	<b>ROBOT: IPx5</b> <b>CHARGING STATION: IPx4</b> <b>BATTERY CHARGER: IPx4</b>		
<b>Electrical features</b>				
Power supply unit (for lithium battery)		Mean Well OWA-60E-30ZCT  Input: 100 - 240 V~; 1.2 A; 50/60 Hz; Class 2 Output: 29.4 V =; 2.0 A	Mean Well ELG-150-30ZCTE  Input: 100 - 240 V~; 2 A; 50/60 Hz; Class 1 Output: 29.4 V =; 5.0 A	Mean Well ELG-240-30ZCTE  Input: 100 - 240 V~; 2.2 A; 50/60 Hz; Class 1 Output: 29.4 V =; 8.0 A
<b>Type of accumulator and charging batteries</b>				
Rechargeable Lithium-Ion Battery (rated voltage)		25.9V 2.9Ah	25.9V 5.8Ah	25.9V 8.7Ah
Type of charging		contact	contact	contact
Average recharging time	hh:mm	2:00	1:30	1:30
Average mowing duration after a full charge cycle (*)	hh:mm	01:30	03:00	04:00

(\*) Depends on the condition of the grass, lawn and the complexity of the mowing area.

Frequencies		
Transmitter for the robot driving		Frequency band of work (Hz) 500 - 60000 maximum radio frequency power (dBm) < 10
Bluetooth		Frequency band of work (MHz) 2402 - 2480 maximum radio frequency power (dBm) < 14
GSM		Frequency band of work (MHz) 850/900/1800/1900 maximum radio frequency power (dBm) < 33
Equipment / Accessories / Functions		
Areas managed, including the primary zone		4
Rain sensor		Standard
Eco Mode -Self-programming (patented)		Standard
Connect module (GPS, GPRS)		Optional
Re-entry method to the charging station		"V-Meter" - "follow wire"
Maximum length of perimeter wire (approximate, calculated based on a regular perimeter)	m (')	1000 (3280')

(\*) Depends on the condition of the grass, lawn and the complexity of the mowing area.

## GENERAL DESCRIPTION OF THE APPLIANCE

The appliance is a robot designed and built to automatically trim grass in gardens and house lawns at any time of the day or night. It is small, compact, silent and easy to transport.

Depending on the characteristics of the surface to be trimmed, the robot can be programmed to work on more than one area: a primary area and secondary areas (according to the specifications of the various models).

During operation, the robot trims the area marked off by the perimeter wire.

When the robot detects the perimeter wire or encounters an obstacle, it changes direction in a random manner and starts mowing again in a new direction. The robot does not cross the perimeter wire for a distance greater than half its length.

According to its operating principle random, the robot automatically trims the entire delimited area of the lawn (see figure).

The robot is able to recognise the presence of higher and/or thicker grass in an area of the garden and to automatically activate, if considered necessary, the spiral movement for a perfect finish.

The lawn surface that the robot is able to trim depends on a series of factors, such as:

- model of the robot and type of batteries installed;
- characteristics of the area (irregular perimeters, uneven surfaces, divided areas, etc.);
- characteristics of the lawn (type and height of the grass, moisture, etc.);
- conditions of the blade (level of sharpness, without residuals and deposits, etc.);

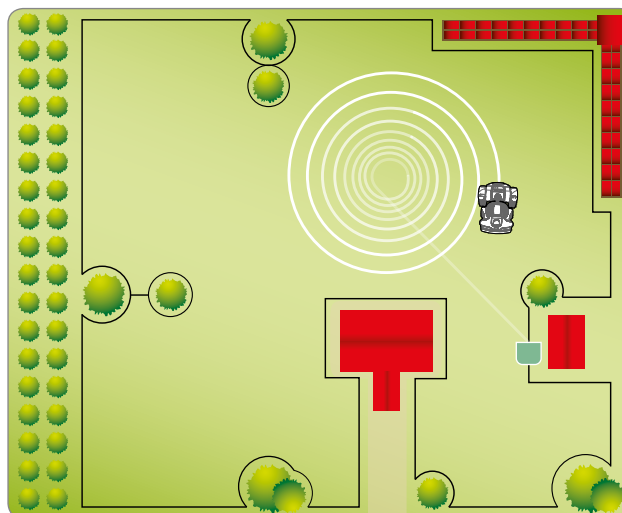
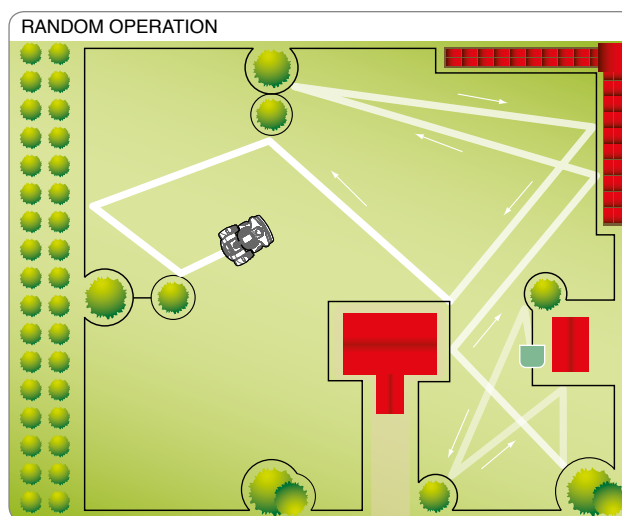

## MAIN PARTS

EN

MODEL		8040BA0, B040BAH
Version		A
①	Robot	✓
②	Keyboard commands	✓
③	Rain sensor	✓
④	Handle	✓
⑤	Cutting blade	✓
⑥	Perimeter wire coil	0
⑦	Pegs	20
⑧	Charging station	✓
⑨	User manual	✓
⑩	Key for adjusting the cutting height	-



### Important

In some commercial setups, the power kit may be sold separately.

POWER KIT		LIGHT	MEDIUM	PREMIUM
⑪	Battery	25.9V 2.9Ah	25.9V 5.9Ah	25.9V 8.7Ah
⑫	Power Supply unit	2.0 A	5.0 A	8.0 A
⑬	Transmitter and Charging Tower	contact	contact	contact
⑭	Charging Module	contact	contact	contact

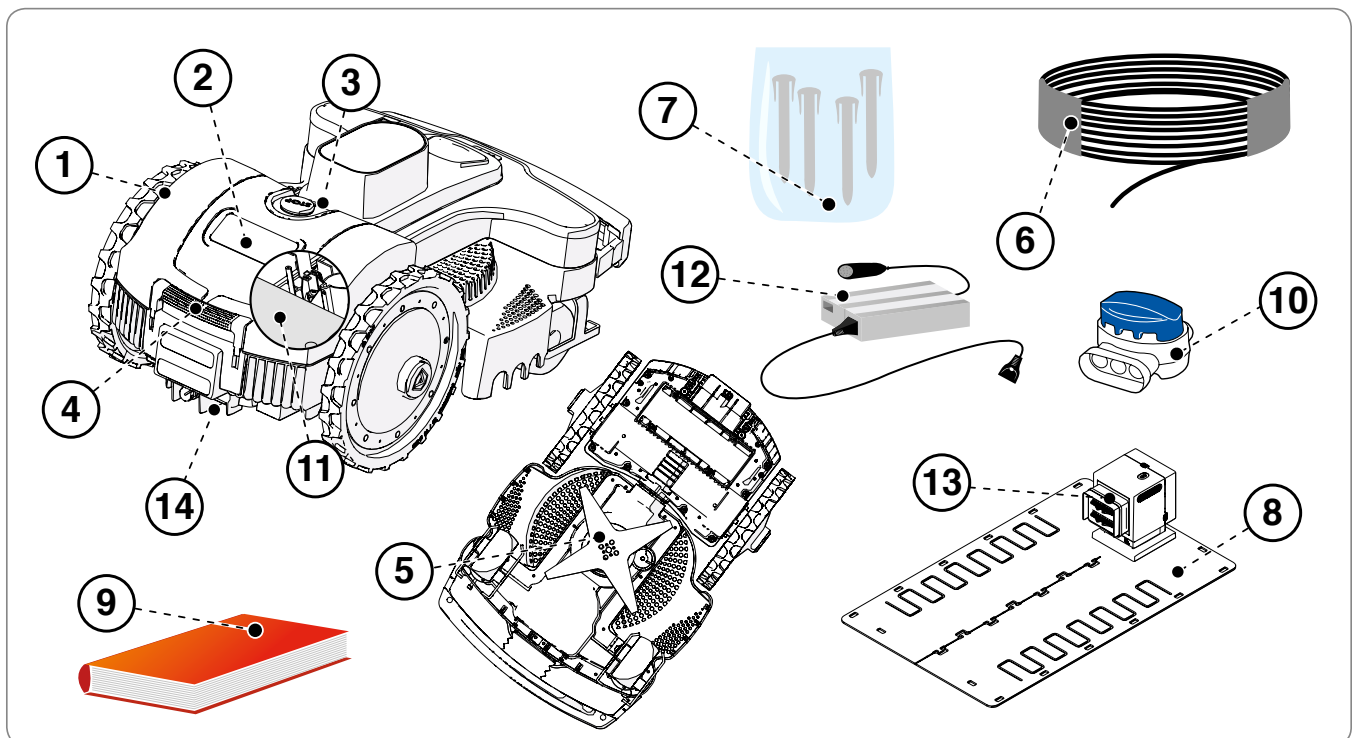

## PACKING AND UNPACKING

The equipment is delivered suitably packaged. When unpacking, carefully remove and check the integrity of the parts.



### Warning – Caution

**Keep plastic wrapping and plastic containers away from infants and children: risk of suffocation!**



### Important

**Keep the packaging materials for future use.**

## PLANNING OF SYSTEM INSTALLATION

The robot is not difficult to install, but requires some preliminary planning in order to find the best area for installing the charging station, power supply unit and for laying out the perimeter wire.

- The charging station must be positioned on the edge of the lawn, preferably in the largest area from which other areas of the lawn are easily accessible. The area where the charging station is installed is hereinafter referred to as the “Primary Area.”



### Warning – Caution

**Position the power supply unit in an area that cannot be reached by children. For example, at a height above 160 cm (63 ").**



### Warning – Caution

**Make sure only authorised people have access to the power supply.**



### Warning – Caution

**When connecting the electricity, it is necessary that a power outlet is positioned near the installation area. Make sure the connection to the mains power complies with the applicable laws. To operate in complete safety, make sure the electrical system, which is connected to the power supply unit, is equipped with a well-functioning earthing system. The supply circuit shall be protected by a residual current device (RCD) with a tripping current of not more than 30 mA.**



### Important

**It is advisable to install the unit in a cabinet for electric components (for outdoor or indoor use), equipped with a key lock, and well-ventilated to maintain a correct air circulation.**

- The robot must be able to easily find the charging station at the end of the work cycle, which will also be the starting point for a new work cycle and for reaching any other work areas, hereinafter referred to as “Secondary Areas.”
- Position the charging station according to these rules:
  - on level ground;
  - on compact and stable ground with good drainage;
  - preferably in the widest part of the lawn;
  - in case of sprinklers, make sure the water jets are not directed inside the charging station;
  - make sure the entrance of the charging station is positioned as shown in the figure, so that the robot can enter it by following the perimeter wire in a clockwise direction;
  - there must be a straight area of 200 cm (78,74 ") in front of the charging station;
  - any metal bars or rails separating the lawn near the station may interfere with the signal. Position the station on a different side of the garden or at a safe distance from the metal barrier. For more information, please contact the Manufacturer’s Technical Service Centre or an authorised dealer.
- The charging station must be well fastened to the ground. To prevent a small step from forming at the front of the charging station, position a small piece of fake grass at its entrance to stop this from occurring. Alternatively, remove part of the grassy surface and install the charging station flush with the grass.

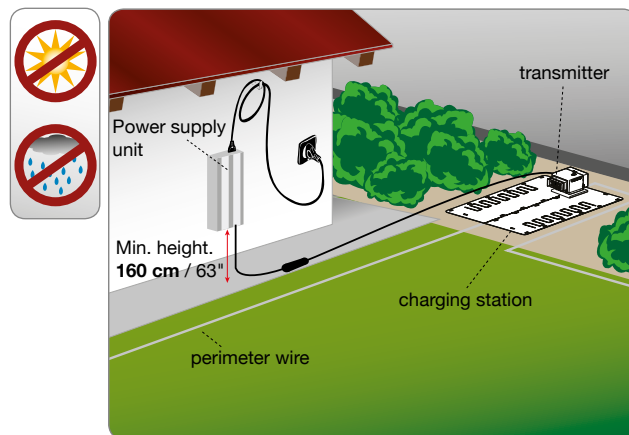

- The charging station is connected to the power supply unit via a cord that must move away from the charging station on the outside of the cutting area.

- Position the power supply unit according to these rules:

- in a well-ventilated area protected against atmospheric agents and direct sunlight;
- preferably inside your home, a garage or shed;
- if positioned outdoors, the robot must not be exposed to direct sunlight and water. Therefore, it must be protected inside a ventilated box. Do not position in direct contact with the soil or humid environments;
- position it on the outside of the lawn and not inside;
- stretch out the excess cord going from the charging station to the power supply unit. Do not shorten or lengthen the cord.

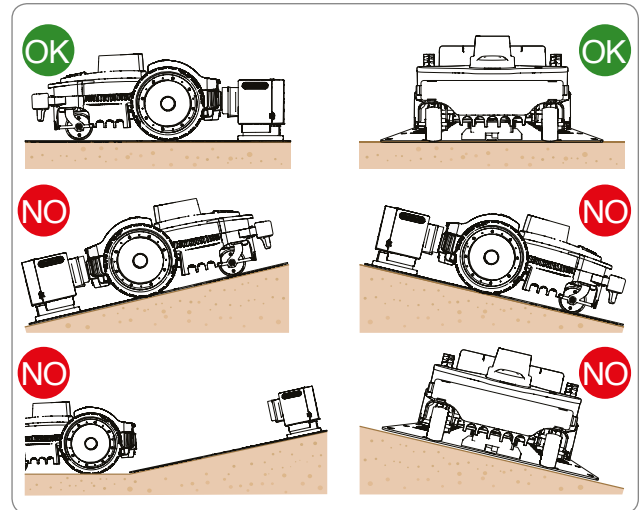

- The incoming section of the wire must be straight and aligned perpendicularly to the charging station by at least 200 cm (78.74 in.) and the outgoing section must move away from the charging station; this allows the correct re-entry of the robot.

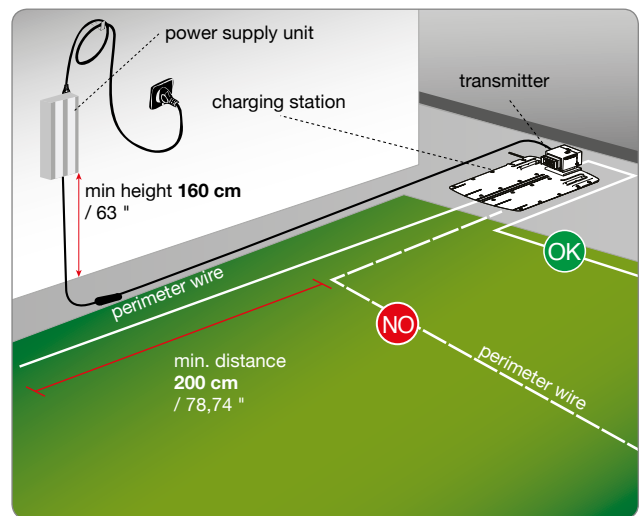

If the robot is installed near an area which has another robot (from the same or another manufacturer), then the transmitter and receiver of the robot must be modified during installation so that the frequencies of the two robots do not interfere with other. In this situation, contact the closest customer service centre.

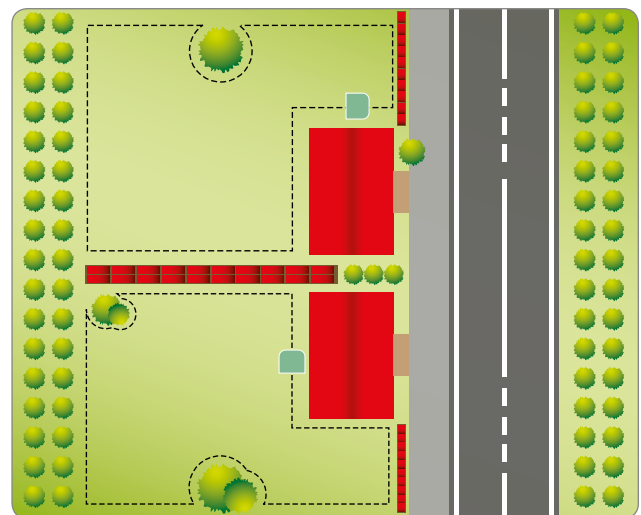



## SETTING UP OF THE PERIMETER WIRE

Before installing the perimeter wire, it is necessary to check the entire surface of the lawn. Make any necessary adjustments to the grassy surface during the laying of the perimeter wire in order to allow the robot to function correctly.

1. Evaluate the best method for returning to the charging station according to the instructions described in the chapter "RE-ENTRY METHOD TO THE CHARGING STATION".
2. Evaluate whether a special installation of the perimeter wire is necessary according to the instructions described in the chapter "SET-UP OF THE ROBOT'S QUICK RE-ENTRY TO THE CHARGING STATION".
3. Preparation and defining of the work areas.
4. Installation of the perimeter wire.
5. Installation of the charging station and power supply unit. When laying the perimeter wire, respect the installation direction (clockwise) and the rotation direction around the flowerbeds (counter-clockwise). As shown in the figure.

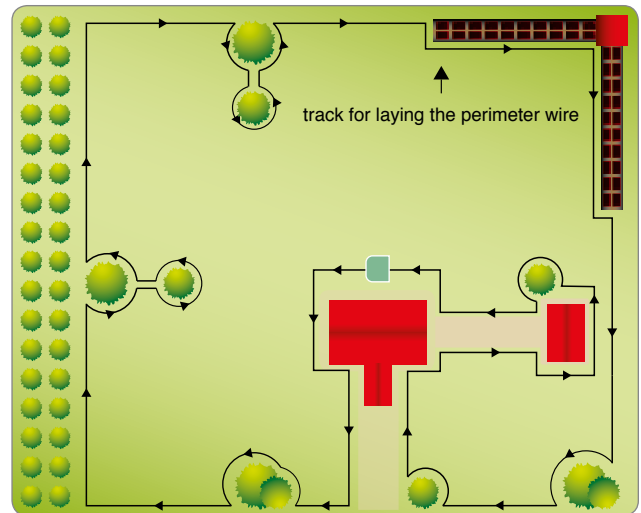

## RE-ENTRY METHOD TO THE CHARGING STATION

The robot can return to the charging station in two different ways based on what is set in the user menu under the field "Settings – Re-entry to Base." Use the "On the Wire" method only when there are numerous obstacles inside the garden and near the perimeter wire (within 2 meters). In all other cases it is better to use the "V-Meter" method for the quickest re-entry to the charging station.

**"Follow wire"**. This method of re-entry to the charging station commands the robot to follow the perimeter wire, positioning its wheels on either side of the wire. If this method is activated, there is no need to prepare the "Recall on Wire" as described below.

**"V-Meter"**. By setting this method of re-entry to the charging station, the robot runs along the perimeter wire at an indicative distance ranging from a few centimetres to one meter (3.2'), touching it every now and again in the curved sections until the signal emitted by the charging station has been recognised for guiding itself on the wire and entering correctly into the charging station.

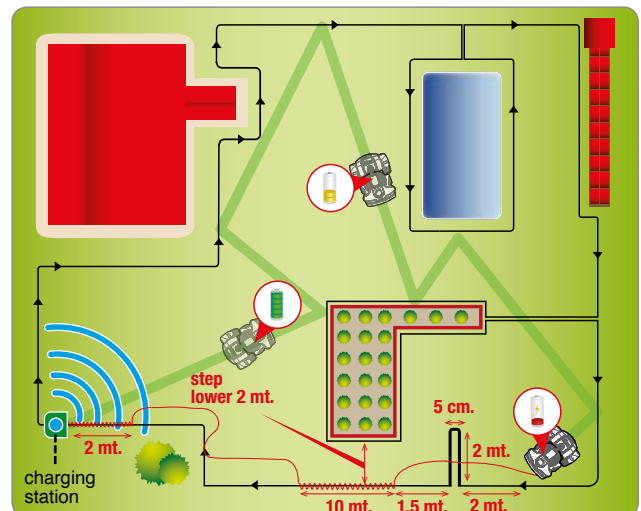

If narrow passages are present or the arrow for quick re-entry to the charging station, the wire must be positioned in a special way, called "Recall on the wire."

As soon as a "Recall" is recognised, the robot will follow the perimeter wire at low speed, and with more precision for around 10 meters (33'). It will then return to the "V-Meter" re-entry mode if the quick re-entry or charging station was not encountered.

Follow these instructions to install the "Recall":

- the "Recall" is a piece of wire that extends for around 2 m (6.6') with a distance of 5 cm (1.96") between each wire;
- the "Recall" must be positioned at a distance of 2 m. (6.6') in front of any narrow passages;
- the "Recall" must be positioned in the section in front of the "Quick Re-entry".

**NB: If the robot does not find the charging station within a certain amount of time, it will follow the perimeter wire in "Follow wire" mode.**



## SETUP OF THE ROBOT'S QUICK RE-ENTRY TO THE CHARGING STATION

Quick re-entry requires a special installation of the perimeter wire that allows the robot to reduce the re-entry path to the charging station. This special installation of the perimeter wire should only be used for gardens where quick re-entry significantly reduces the path and where the perimeter length is greater than 200 meters.

To setup the quick re-entry, position the perimeter wire on the ground so that it forms a triangle with one side of 50 cm (19.7 ") and the other two sides of 40 cm (15.75 ") each, as shown in the figure.

As the robot heads back to the charging station with the two wheels on either side of the wire, it intercepts this triangle and stops moving. It then turns approximately 90° towards the inside of the garden and starts moving in the new direction until running into the perimeter wire on the opposite side.

Arrange the wire for quick re-entry in a point where there is at least 200 cm (78.74 ") of straight wire in front of the station, and at least 150 cm (59.05 ") of straight wire behind it.

Do not set up the wire along the straight section immediately in front of the charging station or near any obstacles. Make sure there are no obstacles along the re-entry path that may obstruct the quick re-entry.

Do not set up the wire along excessive slope, so that the robot can recognize it easily. The maximum slope depends on the lawn conditions. It should remain under approximately 20%.



### Important

**An incorrect setup of the robot's quick re-entry may prevent the robot from returning to the charging station quickly. When the robot travels along the perimeter to reach a secondary area, it may not detect the quick re-entry setup.**

The illustration provides some useful tips on how to correctly setup the robot for a quick re-entry.

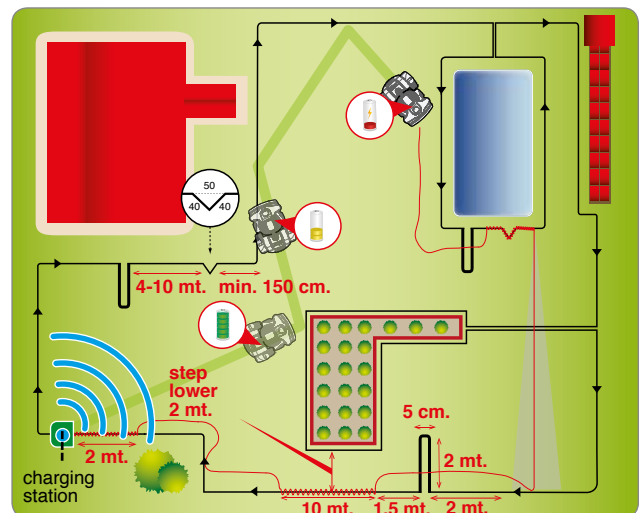

## Preparation of the lawn to be mowed

1. Make sure the lawn to be mowed is even and does not contain holes, stones or other obstacles. If necessary, prepare the lawn by filling in any holes and removing any obstacles. If some obstacles cannot be removed, it is necessary to properly mark these areas with the perimeter wire.
2. The robot can mow surfaces inside the working area with a maximum slope of 45% (45 cm per meter in length) on a regular dry lawn, with no risk of wheels slipping, based on the accessories installed. In the other cases it is necessary to respect the 35% of the slope.

The perimeter wire must be laid on the ground sloping no more than 20% (20 cm per meter in length), being in mind that the robot requires greater grip during the return to the charging station. Therefore, it is necessary to check carefully the lawn conditions and to respect the limits.

The slope must not increase at least 35cm inside or outside the perimeter wire. If these instructions should not be complied with, while the robot is working on sloping areas and detects the wire, its wheels could slip and make it leave the working area.

If there are any obstacles on slopes that are closed to the abovementioned limits, the ground must be uniformed for at least 35cm in the part uphill of the obstacle to reduce the slope.

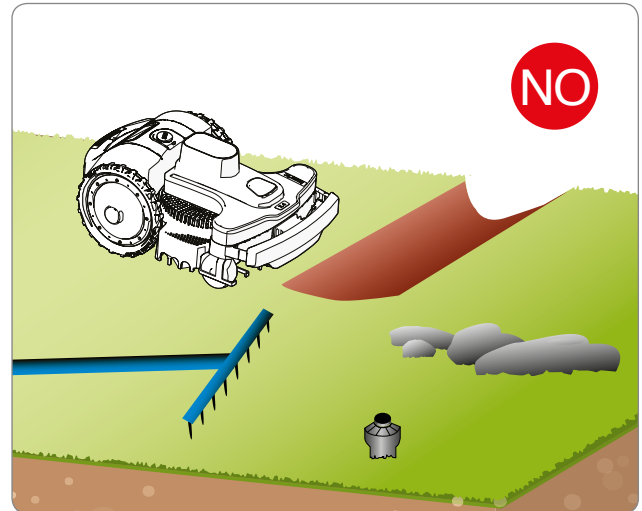

### Important

**Areas with slopes greater than those allowed cannot be mowed with the robot. Therefore, position the perimeter wire in front of the slope so that it is excluded from the area to mow.**

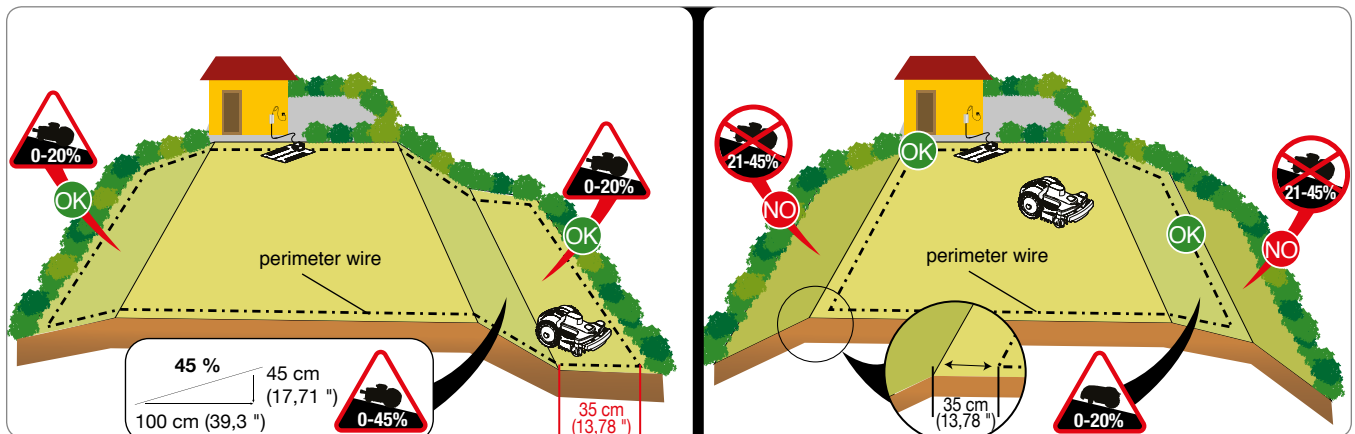

## Marking the boundary of the work area

3. Check the entire lawn surface and assess whether it is necessary to divide it into separate work areas as per the rules described here below. Before installing the perimeter wire, check the entire path to make this procedure easier. The illustration shows a lawn with the track for installation of the perimeter wire.

During installation, identify any secondary areas. A secondary area is part of a lawn connected to the primary lawn with a passage that is difficult to reach by the robot's normal movement. The area must be reachable without any rises or drops greater than those allowed. Whether a zone is to be defined a "secondary area" also depends on the size of the primary area. The larger the primary area, the harder it will be to reach narrow passages. More generally, a passage narrower than 200 cm (78.74") is considered a secondary area. The number of secondary areas managed depends on the characteristics of the model (See "Technical Specifications").

The minimum passage allowed is **70 cm** (27.56") from each edge of the perimeter wire. The perimeter wire must be positioned at a distance of (to be indicated below) from any objects outside the lawn; therefore, the necessary space for passing must be **140 cm** (55.12") if there is a wall or hedge on both sides.

If this passage is very long, the width should be more than **70 cm** (27.56") between perimeter wires.

During programming, it is necessary to configure the size of the areas and the quickest direction to reach them (clockwise or counter-clockwise), as well as the number of meters of wire needed to reach the secondary area. See "Programming Mode."

If the aforesaid minimum requirements are not met i.e. an area separated by a rise or drop with characteristics that cannot be managed by the robot or a passage (corridor) narrower than **70 cm** (27.56") from perimeter edge to perimeter edge, then this area of the lawn is considered a "Closed Area." To mark a "Closed Area" lay the outgoing and incoming perimeter wire in the same track at a maximum distance of **1 cm** (0.40"). In this case, the robot is unable to reach the area autonomously, and must be managed as described in the chapter "Management of Closed Areas." The management of "Closed Areas" reduces the square meters that can be managed autonomously by the robot.

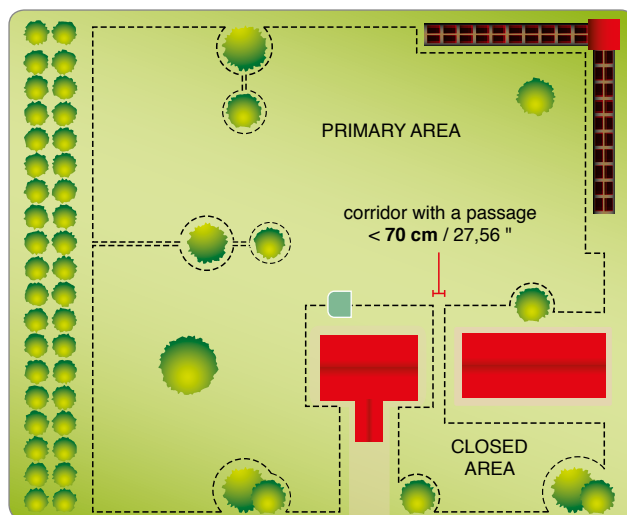
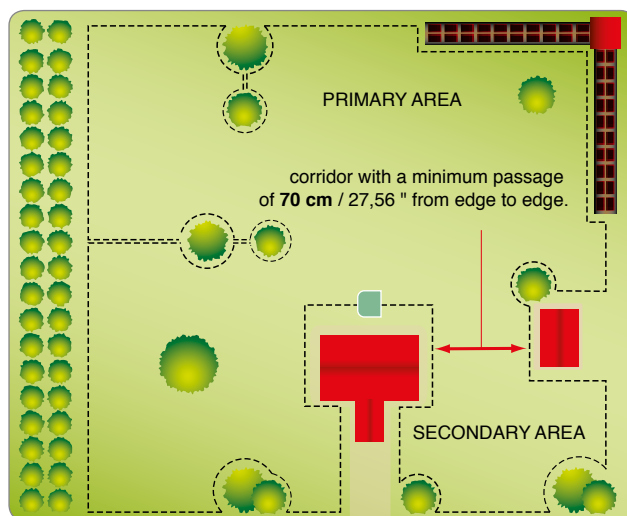
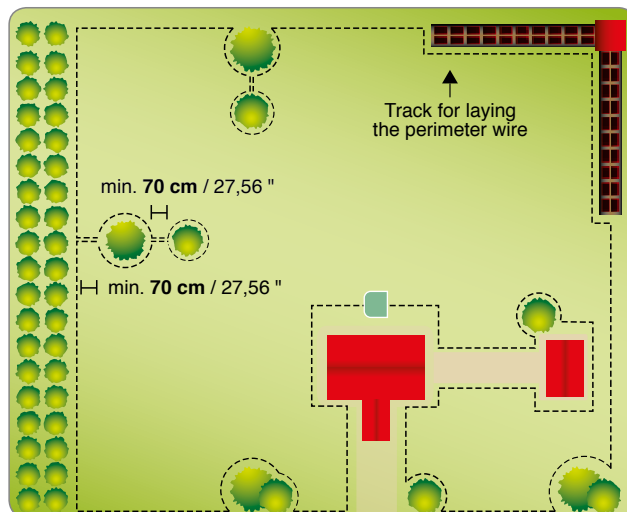

4. If there is a pavement or driveway inside or outside the work area, which is at the same level of the lawn, lay the perimeter wire at a distance of 5 cm (1.96 ") from the edge of the pavement. The robot will come out slightly from the lawn and all the grass will be mowed. If the pavement is made of metal or if there is a metal manhole cover, shower plate or electrical wires, lay the perimeter wire at least 30 cm (11.81 ") from the metal object in order to prevent malfunction of the robot and disturbances on the perimeter wire.

**i** Important

The illustration shows an example of the elements inside and on the perimeter of the work area and the distances to follow for the correct laying of the perimeter wire. Mark the boundary of elements in iron or other metals (drain covers, electric connections, etc.) to prevent any interferences to the signal of the perimeter wire.

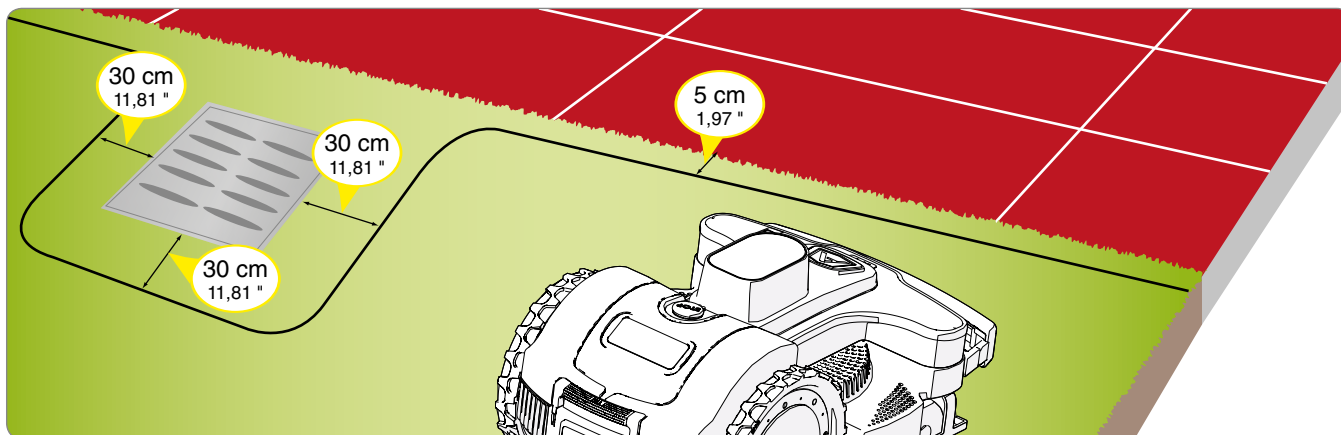

If an obstacle is present inside or outside the work area, such as a kerb or wall, lay the perimeter wire at least 35 cm (13.78") from the obstacle. Increase the distance between the perimeter wire and the obstacle; if you don't want the robot to hit the obstacle, place the perimeter wire at least 40 cm (15.75") away from it. Any grass close to the edge and outside the defined work area can be cut with a grass trimmer or brushcutter.

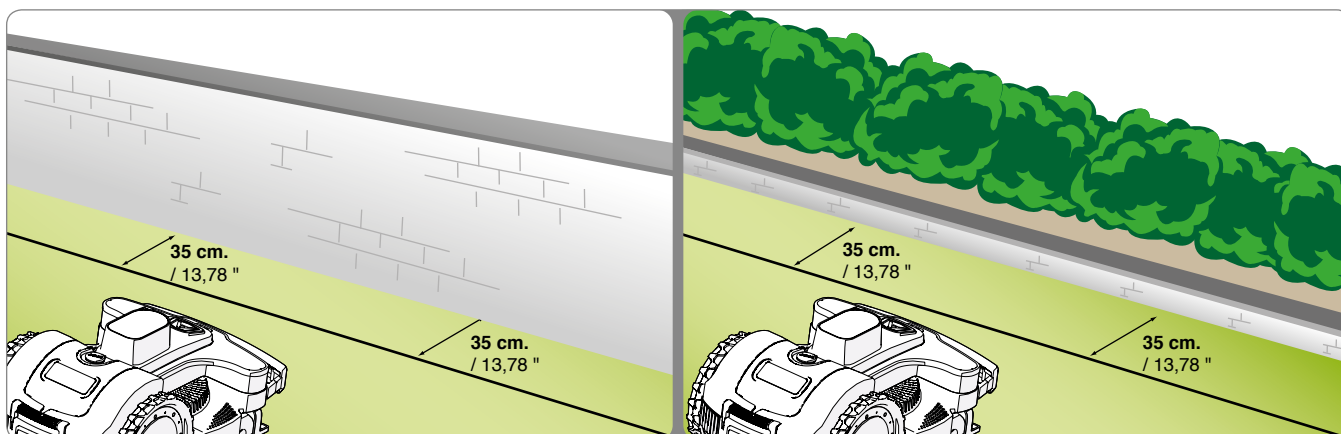

If a flower bed, hedge, plant with protruding roots, small ditch of 2-3 cm or small kerb of 2-3 cm is present inside or outside the work area, lay the perimeter wire at least 30 cm (11.81 ") from the obstacle to prevent damage being done to the robot or the obstacle.

Any grass present inside the work area can be cut and finished with a grass trimmer or brushcutter.

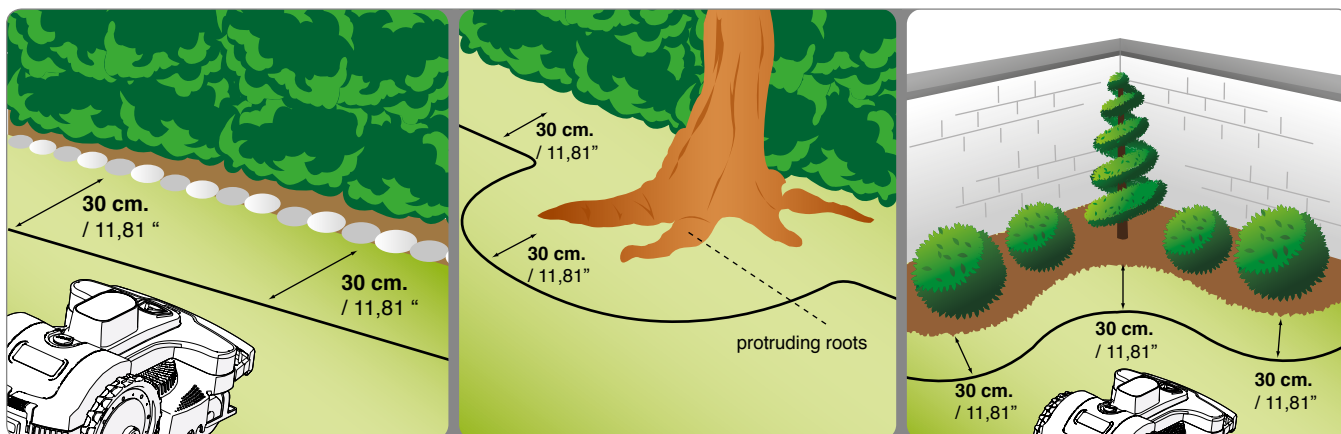

If there is a pool, pond, ravine, ditch, steps or public roads not protected by an easily crossable fence or wall inside or outside the work area, install the perimeter wire at least 90 cm (35.43 inches) from the edge. In order to install the perimeter wire as close as possible to the edge of the cutting area, we recommend installing a fence that is difficult to cross if adjacent to public areas, or a fence at least 15 cm high in other cases. This will allow laying the perimeter wire at the distances described in the previous paragraphs.

**i** Important

**Carefully follow the distances and slopes specified in the booklet to guarantee excellent installation and proper functioning of the robot. Increase the distance by at least 30 cm (11.81 ") in the presence of slopes or slippery ground.**

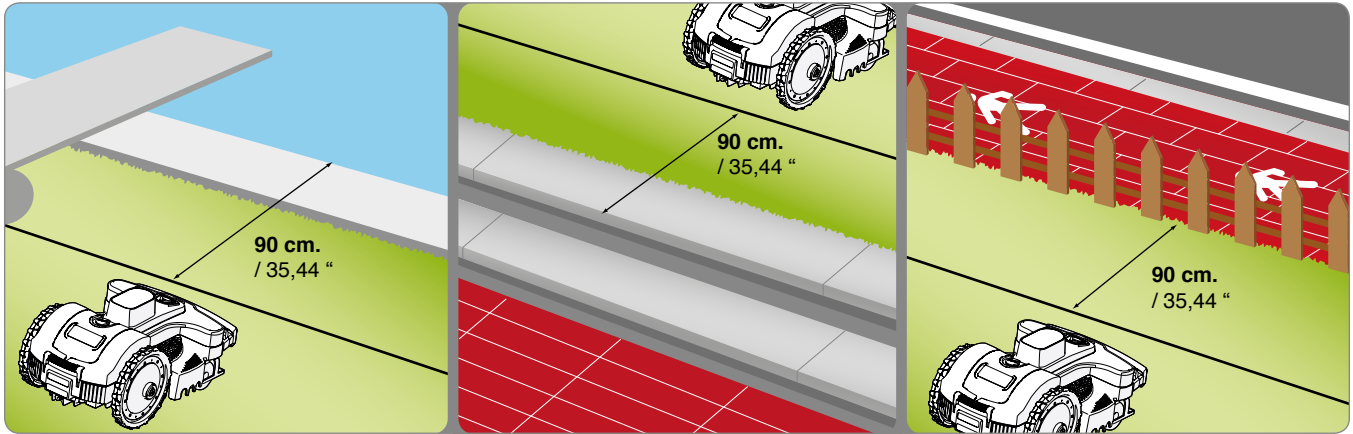

Obstacles resistant to knocks, such as trees, bushes or poles without sharp edges present inside the work area do not need to be delimited. The robot hits the obstacle and changes direction. If you don't want the robot to knock into the obstacles and for its safe and silent operation, all the fixed obstacles need to be delimited. Slightly sloping obstacles such as flower pots, stones or trees with protruding roots must be delimited to protect the cutting blade and the obstacles themselves.

To mark the boundary of the obstacle, start from the outside point of the perimeter nearest the object to delimit, arrange the perimeter wire so that it reaches the obstacle, goes around it and then travels back along the previous path, observing the regular distances described in the previous paragraphs. Overlap the outgoing wire and the incoming wire so that they pass under the same peg, this will allow the robot to go past the perimeter wire.

For the robot to function correctly, the minimum overlapping length should not be greater than 70 cm (27.56 ") in order to allow the robot to move regularly.

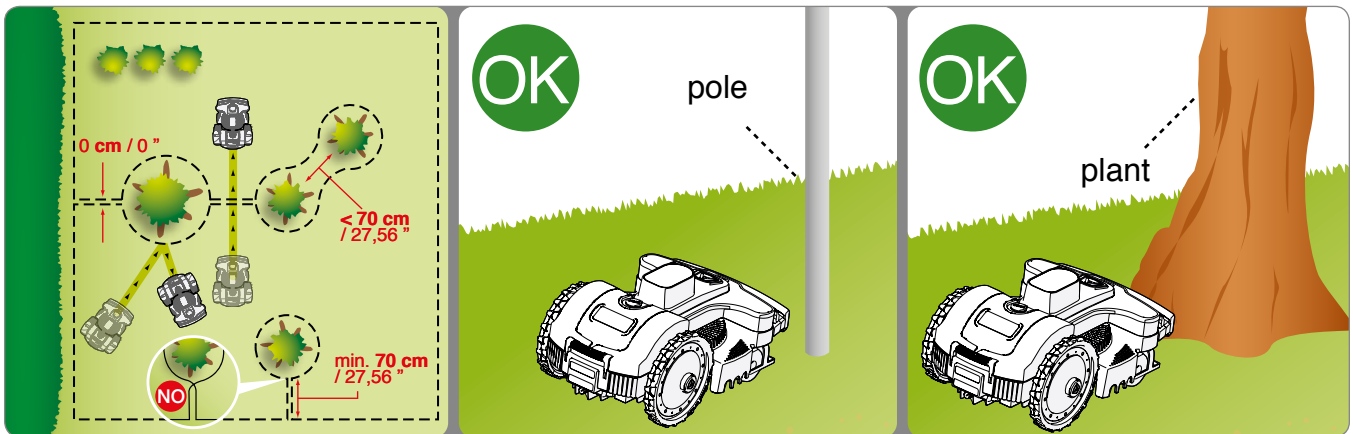



## INSTALLATION OF PERIMETER WIRE

The perimeter wire can be buried or laid on the ground. If you have a wire layer machine, it is better to bury the wire for greater protection.

Otherwise, install the wire on the ground with the pegs provided as described below.



### Important

**Start laying the perimeter wire from the area where the charging station is installed, leaving a couple of extra meters so that it can be cut down to size when connecting to the power unit during the final phase.**

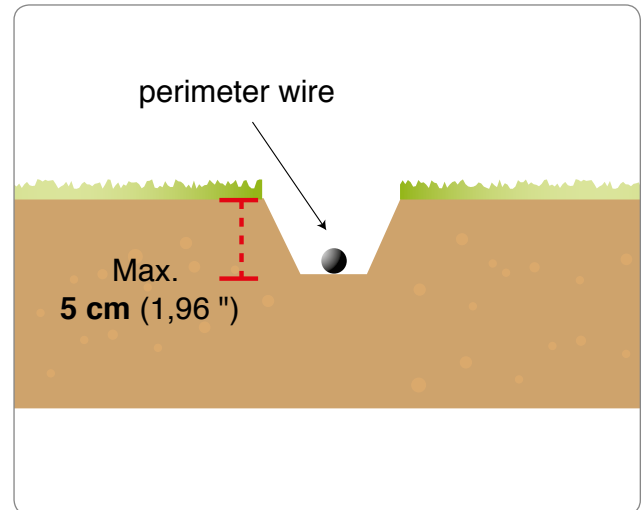

### Ground wire

Cut the grass as low as possible with a grass trimmer or brushcutter along the entire path where the cable will be laid. This will make it easier to lay the cable in contact with the ground and reduce the risk of the robot damaging the insulation.

1. Position the wire in a clockwise direction along the entire path and secure it with the pegs supplied, making sure there is a maximum distance of around 100 cm (39.37 inches) between each peg. The wire must be in contact with the ground to prevent it from being damaged by the robot before the grass covers it.
  - When laying the perimeter wire, follow the installation direction around the flowerbeds, i.e. a counter-clockwise direction.
  - In curved sections, secure the wire so that it is not twisted, but curves nicely (radius of 20 cm).

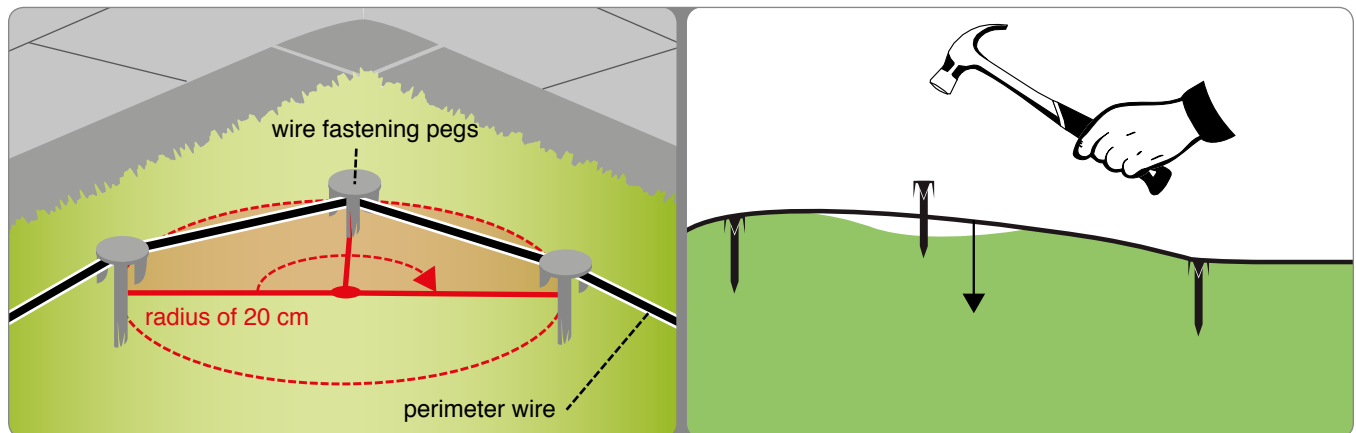
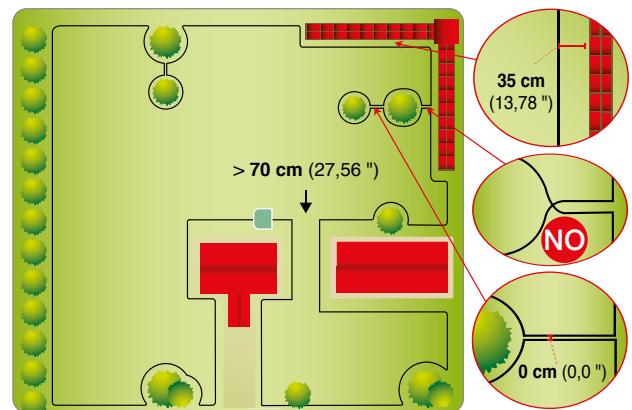

### Buried wire

1. Dig an even furrow in the ground (approximately 2-3 cm or 0.787-1.181 ").
2. Position the wire in a clockwise direction along the track at a depth of a couple of centimetres. Do not bury the wire deeper than 5 cm, so as not to reduce the quality and intensity of the signal picked up by the robot.
3. During the laying of the wire, it may be necessary to secure it in some points with the pegs provided in order to hold it in place when covering with the ground.
4. Cover all the wire with soil and make sure it remains taut in the ground.

## Joining of the perimeter wire

Use an original joint if another perimeter wire is needed to complete the installation.

Insert each end of the wire in the joint, making sure the wires are fully inserted so that the ends are visible on each side. Press the button on the upper side all the way down using a pair of pliers.



### Important

- For a safe and secure electrical connection, only use original joints.
- Do not use insulating tape or other types of joints that do not provide proper isolation (lugs, terminals, etc.). After some time, soil moisture causes oxidation and interruption of the perimeter wire.

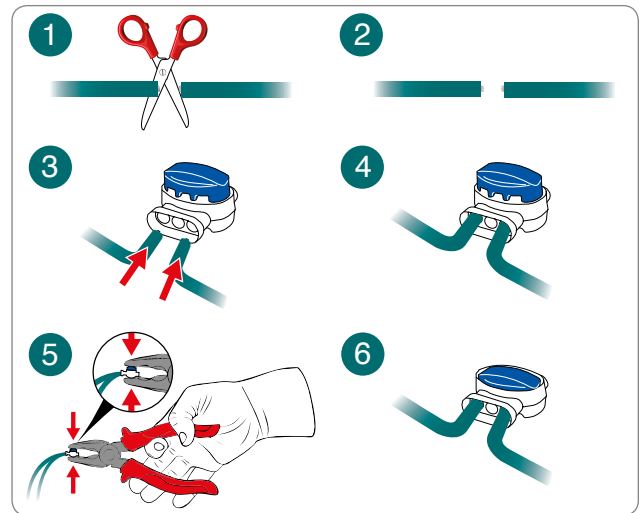

## INSTALLATION OF THE CHARGING STATION AND POWER SUPPLY UNIT



### Warning – Caution

Before carrying out any operations, disconnect the robot from the mains power.

Position the power supply unit in an area that cannot be reached by children. For example, at a height above 160 cm (63").

Do not shorten or lengthen the cable getting to the charging station, wrap as an 8 like form the excess cord, as shown in the figure.

The perimeter wire used for the installation cannot be less than 50m, contact the closest customer service centre .

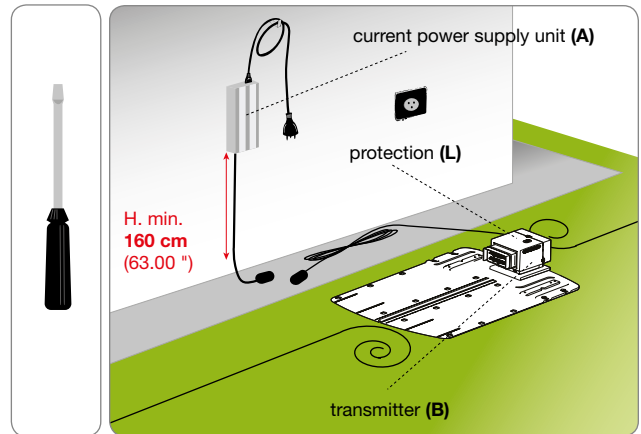

1. Position the charging station in the predefined area.
2. Insert the perimeter wire (M) along the guide in the charging station. Cut the excess perimeter wire to about 5cm above the connectors.
3. Connect the station incoming wire to red terminal of the transmitter (T). Connect the station outgoing wire to the black terminal.



The terminals are used only to connect the original perimeter wire.

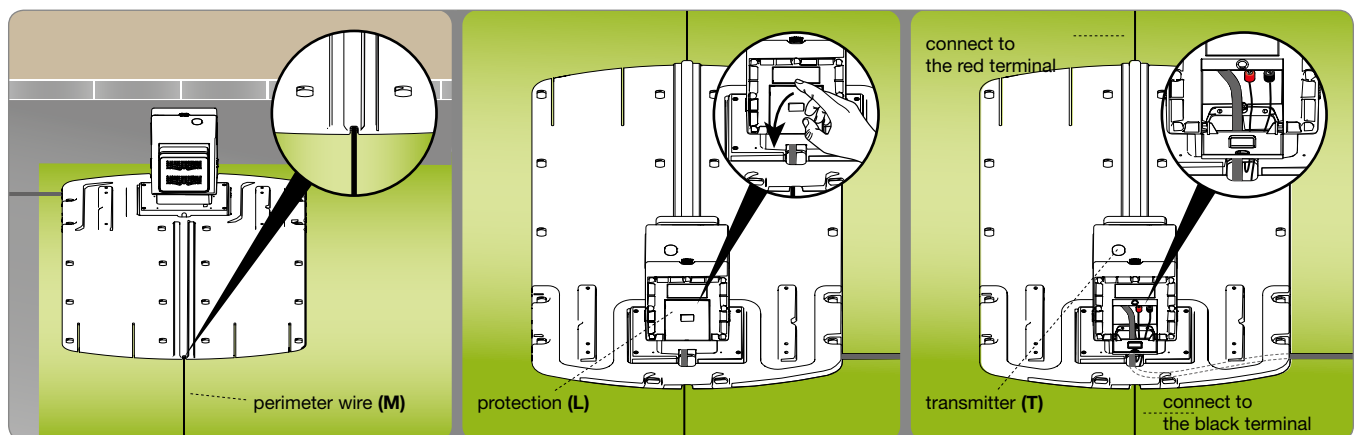



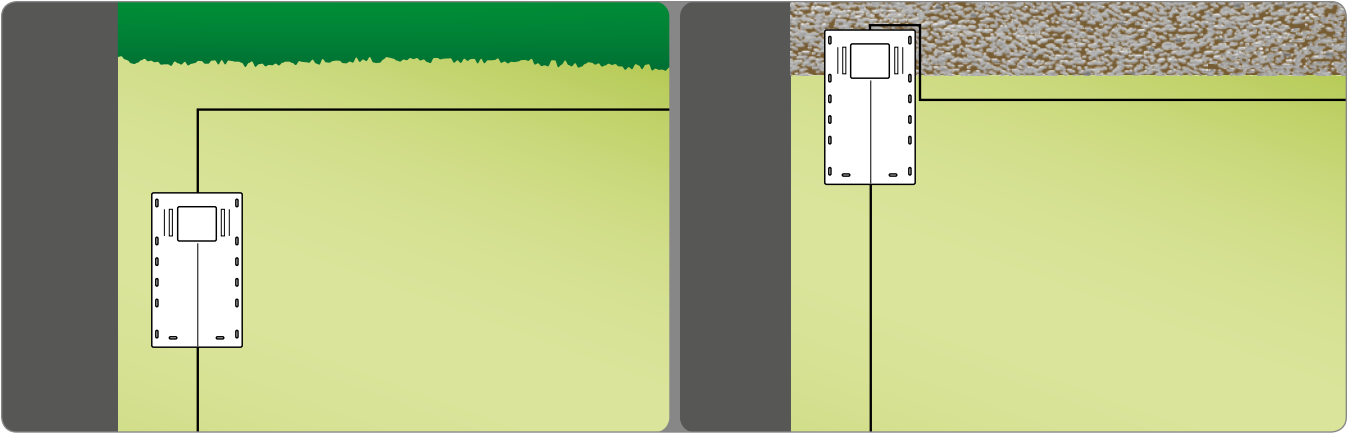

4. Fasten the charging station (N) to the ground with the pegs (P). If necessary, secure the charging station with screw anchors (Q).

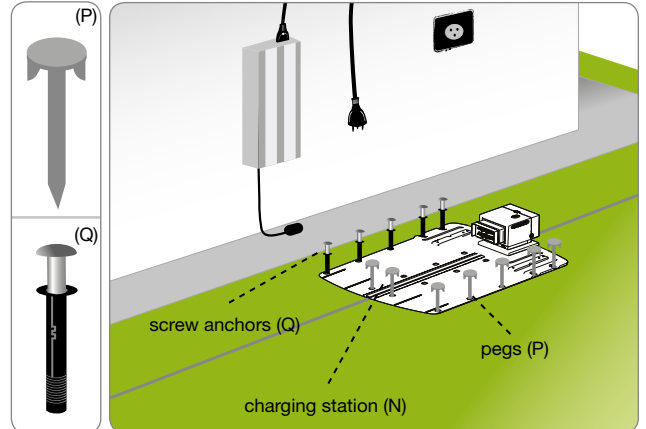

5. Install the power supply unit (A).  
 6. Connect the power cord (E) of the charging station (N) to the power supply unit (A).  
 7. Connect the plug of the power supply unit (A) to the electrical outlet.  
 8. If the LED of the transmitter flashes, the connection is correct. Otherwise, find the anomaly (see "Troubleshooting Guide").  
 9. Replace the protection (L).

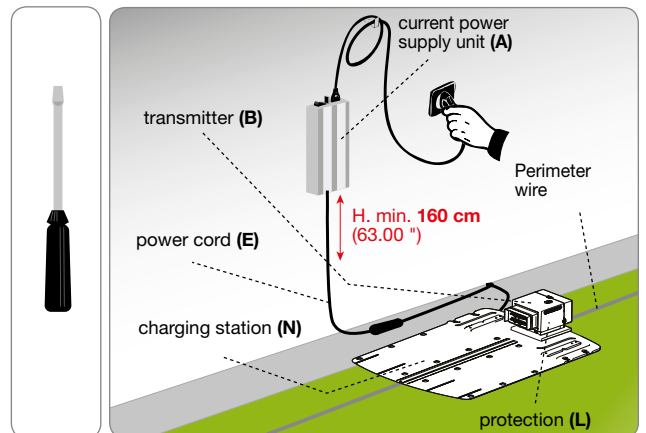

## BATTERY CHARGING ON FIRST USE

1. Place the robot inside the charging station.
2. Press the ON/OFF key and wait a few seconds for the robot to turn on completely.
3. The battery LED turns orange and remains fixed for a few seconds during recognition of the charging station.
4. Make sure the AUTO LED is off, if necessary press the AUTO key to turn it off.
5. At the end of charging, the robot can be used or programmed for initial start-up (see "Programming Mode").



### Important

**On first use, always charge the batteries for at least 4 hours.**

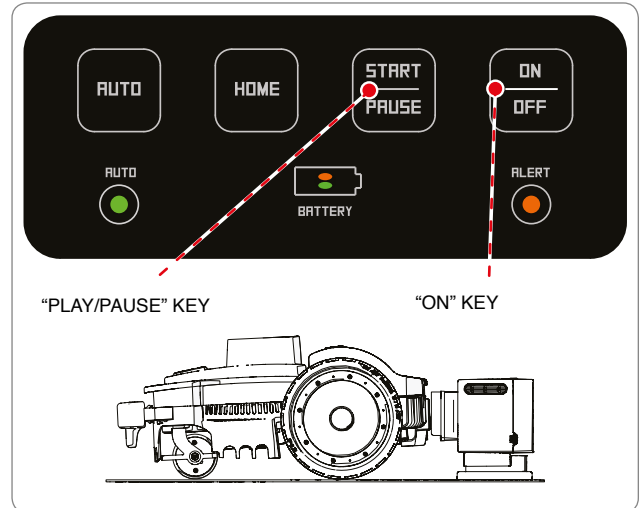

## ADJUSTMENTS

### ADJUSTMENT RECOMMENDATIONS



### Important

**The user must make any adjustments according to the procedures described in this manual. Do not make any adjustments which are not expressly indicated in this manual. Any special adjustments, not expressly indicated in this manual, must only be performed by personnel from the Manufacturer's authorised service centre.**

### ADJUSTMENT OF CUTTING HEIGHT

Before setting the cutting height of the blade, make sure the robot is safely off (see "Robot Safety Stop").



### Important

**Use protective gloves to prevent injuries to your hands.**

1. Turn over the robot and position it so as not to ruin the hood.
2. Turn the bracket (E) in a clockwise direction with the key provided.
3. Lift or lower the cutting unit (D) to set the desired cutting height. The value can be measured using the graduated scale found on the key provided.



### Important

**Do not use the robot to mow grass which is 1 cm (0.40 ") higher than the cutting blade. Reduce the cutting height gradually. It is recommended to reduce the height by at least 1 cm (0.40 ") every 1-2 days until the ideal height is reached.**

4. Once the adjustment has been made, turn the bracket (E) in a counter-clockwise direction.
5. Turn the robot back over to its operating position.

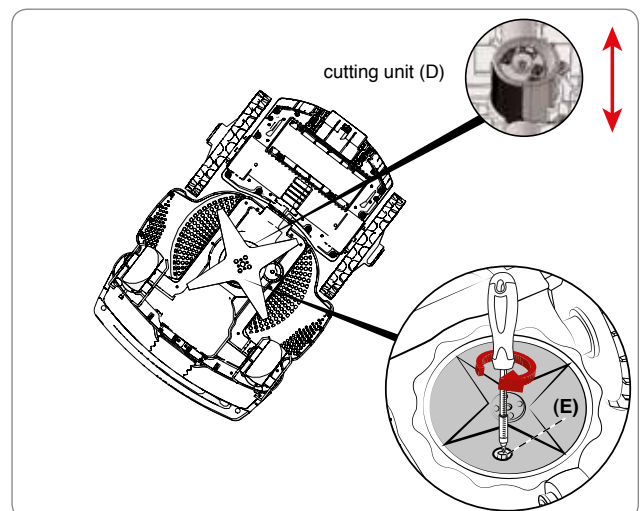



### Important

- When using the robot for the first time, carefully read the entire manual and be sure to fully understand it, especially the safety recommendations.
- Only use the robot for its intended purpose as described by the Manufacturer and do not tamper with any device to obtain different operating performances.
- Do not use the robot and its peripheral units in bad weather conditions, especially when there is a risk of lightning.

## DESCRIPTION OF CONTROL PANEL AND MENU OVERVIEW

The illustration shows the location and function of the controls on the machine.



### STOP

Press to stop the robotic mower safely. Only use in case of imminent danger and to perform maintenance on the robot.

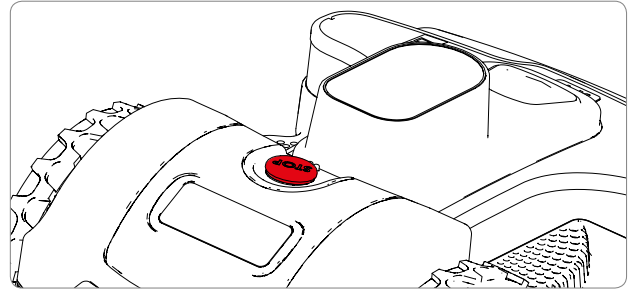

Press to turn the robot on and off.



Press to enable or disable automatic operation. When in automatic mode, the robot is programmed to work according to the program described in the following pages.

### AUTO



Off: Manual operation.  
Fixed on: Automatic operation.



BATTERY

Battery charge level.

### ALERT



Operating errors. Refer to the chapter "TROUBLESHOOTING"

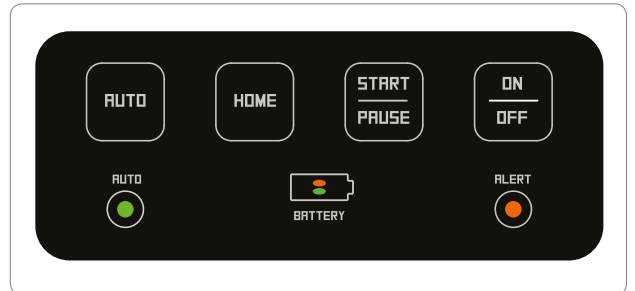

### Robot in charging station (AUTO LED off)



Press to start a manual work cycle. If the battery is sufficiently charged and the AUTO LED is off, the robot starts a work cycle. When the work cycle is completed, it goes back to the charging station.

### Robot in the garden



When the robot is moving, this suspends the mowing operation and places the robot in stand-by mode.

With the robot in Stand-by, this allows resuming the mowing operation.



Returns to the charging station and resumes automatic or manual operations depending on the status of the "AUTO" LED.

---

## SET UP

---

The set up procedure is performed when the robot is started for the first time and after a long period of inactivity.

- Check that the height of the lawn surface to be cut is compatible with the proper functioning of the robot (see “Technical Specifications”).
- Adjust the cutting height as desired (see “Adjustment of Cutting Height”).
- Make sure the work area has been correctly marked and that there are no impediments to the regular functioning of the robot as described in the section “Preparation and Marking of Boundaries of the Work Areas” and following sections.
- Make sure there are no large puddles in the garden due to heavy rain.
- Place the robot inside the charging station.
- Press the ON/OFF key and wait a few seconds for the robot to turn on completely.
- The battery LED turns orange and remains fixed for a few seconds as it recognises the charging station.
- The robot is ready for use. Press the “AUTO” key to set automatic or manual operation.

### Operation of the robot in manual mode with “AUTO LED off”

- When the battery is fully charged, press the START/PAUSE key to start the work cycle. When the battery capacity is exhausted, the robot returns to the charging station.
- If the garden has not been completely mowed, wait until the battery is fully charged and then start a new work cycle.
- For a better result, it is recommended to use the robot at least on every other day.
- To change the default settings of some robot functions, simply download the free application for smartphones; refer to section “ACCESS TO MENU VIA APP”.

### Operation of the robot in automatic mode with “AUTO LED on”

- Thanks to the automatic mode the robot is programmed to work every day of the week. Through the mobile application you can check the default time set.
- The number of work cycles is managed automatically by the robot based on the battery capacity. In automatic mode, the robot exits the charging station to perform the work cycle and returns to recharge itself, and if necessary, to resume working again.
- To change the default settings of the working time and other functions, simply download the free application for smartphones, refer to paragraph “ACCESS TO MENU VIA THE APP”.

---

## USE OF THE ROBOT IN CLOSED AREAS WITH NO CHARGING STATION



---

The start-up of the robot in “closed area” mode is for mowing closed areas that are marked off by the perimeter wire and have no charging station.



### Danger - Attention

**Carry the robot using the handle provided. Do not grab the robot by the body and always use the handle provided.**

1. Position the robot inside the work area at a minimum distance of 100 cm (39.37 in.) from the perimeter wire and from any other obstacles.
2. Press the ON/OFF button and wait a few seconds for the robot to turn on completely. Follow the instructions in the display and enter the password, if prompted.
3. Connect to the robot using the APP on your smartphone and select the button .
4. Select the “closed area” key. .
5. Set the time for the end of the working cycle, and select “OK”.

At the end of the working cycle, stop the robot in safe conditions (see “Robot Safety Stop”) and carry it back to the area where the charging station is located.

Restore the normal functioning of the robot as described in chapter “INITIAL START UP”.

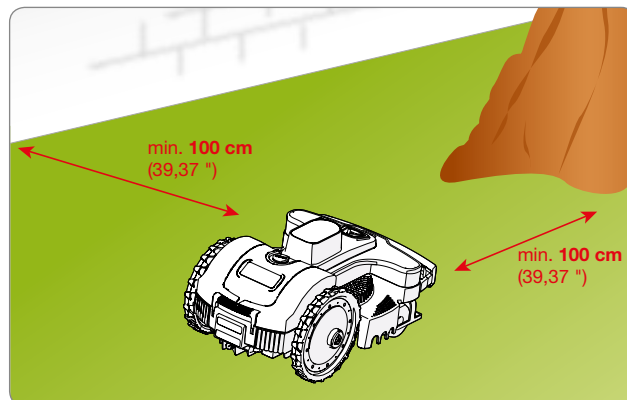

---

## ACCESS TO THE MENU VIA APP

---

The robot has a built-in Bluetooth device that allows it to be programmed and controlled using a smartphone.

Download the Android and iOS app for your smartphone from the product’s website. Start the application and follow the wizard to pair the Robot to your device.

The factory set PIN is “0000.” Change the PIN as soon as possible to make the robot safe.

The application allows you to:

- Change the automatic standard working time.
- Set the operation of the rain sensor.
- Set the departure points to optimally manage the secondary area.
- Change the password.
- Send the Start / Pause / Home command.
- Guide the robot during the cutting.
- Display the status, alarms and any errors of the robot.

---

## SETTING THE USER MENU VIA THE MOBILE APPLICATION

---

Start the application from your smartphone and access the robot programming menu via the “Setup” function.

Follow the introduction containing a summary of the programming functions available. Details of each function are found in the pages following the flow diagram. The functions marked with (\*) are only available on some models. See the “Technical Specifications” table.

## Robot Programming

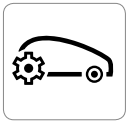

### Important

- To get the best out of the robot, it is recommended to program the robot to work every day.
- If several working areas need to be set, it is recommended to program at least two working schedules in order to increase the cutting frequency in the areas.

### Setting of timer

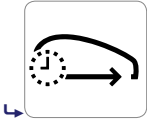

Three different working profiles can be set for using at specific times. This is particularly useful when you want to use the garden at a different time than usual.

The last profile set remains highlighted in a different colour and will be active during the automatic operation of the robot.

Press the button a few times to go to the main menu.

### Work schedule



Up to 4 working schedules can be set for each day of the week.

Press the area of the display corresponding to the day you want to configure, and then select the times.

### Daily schedule

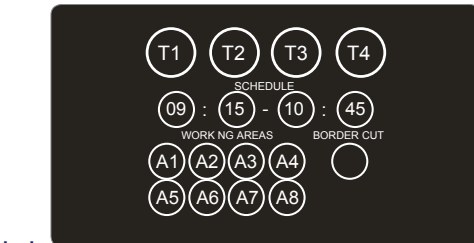

For each working schedule (T1,T2,T3,T4) set the start time, end time and the mowing areas.

**⚠ Times T1,T2,T3,and T4 must not overlap, the robot will delete any conflicting times.**

“Edge cutting”. This function enables the robot to start working by cutting along the edge of the lawn. This function should be activated at least twice a week.

For example, if you set:

**T1:** 09:00 - 11:00, A1, A2, A3, A4

**T2:** 15:00 - 17:00, A1, A2

The robot operating between the hours 15:00-17:00 will perform the mowing cycle only in the A1 or A2 working area.

**⚠ The robot can enter areas A3 and A4 when it has to reach a working area, return to the charging station or work randomly.**

The setting of the time is essential for the robot’s proper functioning. Many parameters influence the setting of the working schedules, such as the number of areas, capacity of the batteries, complexity of the lawn, type of grass, etc. Generally, the working hours must be increased slightly when mowing gardens with more than one area, and gardens with lots of obstacles and complicated areas. Below is a table with the indicative times for configuring the robot on first use.

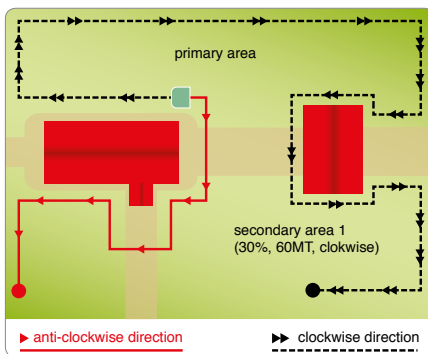

m <sup>2</sup> (ft <sup>2</sup> )	T1	T2	T3	T4
400 (4304')	10:00 11:00	14:00 15:00		
800 (8608')	10:00 11:00	14:00 18:30		
1200 (12912')	10:00 13:00	15:00 18:00		
1800 (19418')	09:00 21:00			

### Re-entry to charging station

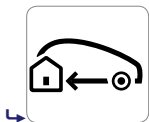

Sets the distance between the robot and the perimeter wire during its re-entry to the charging station.

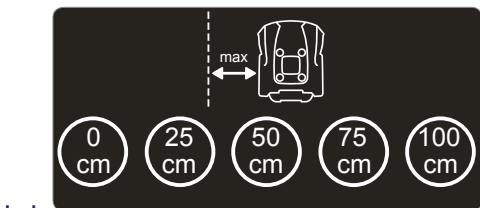

“0 cm”. This setting is recommended for complex gardens with many obstacles near the perimeter wire and gardens with narrow passages. The robot will position its wheels on either side of the perimeter wire to return to the charging station.

**⚠ Install the perimeter wire using the “On the Wire” method, refer to the section “Re-entry method to the charging station”.**

With the remaining parameters the robot returns to the charging station while maintaining the approximate distance set from the perimeter wire. This option is recommended for gardens with steep slopes and/or gardens without bumps near the perimeter wire.

**⚠ Install the perimeter wire using the “V-Meter” method, refer to the section “Re-entry method to the charging station”.**

### Rain sensor



Sets the behaviour of the robot when the sensor detects rain.

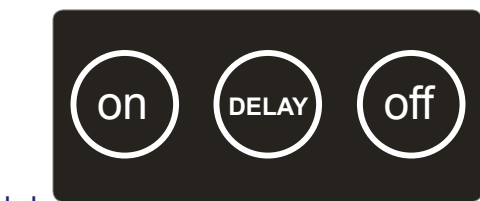

**ON:** when rain is detected, the robot returns to the charging station. At the end of the charging cycle, the robot resumes its normal operation if the sensor no longer detects rain.

**DELAY:** when rain is detected, the robot returns to the charging station and stays there for the time set, which can be configured in the next screen when the “Delay” button is pressed.

**OFF:** the rain sensor is turned off.

### Garden set up

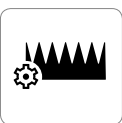

Sets the characteristics of the mowing zone.

**⚠ In gardens with one area, at least one zone must still be set.**

#### Setting of work area

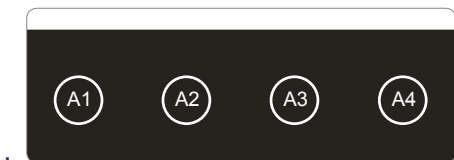

Up to 4 areas can be set. Press the area that you want to configure. To disable an area, set the size to 0 m<sup>2</sup>.



## Work schedule

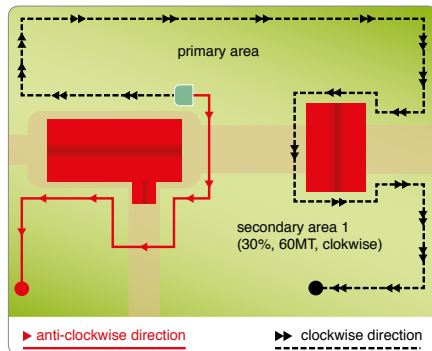
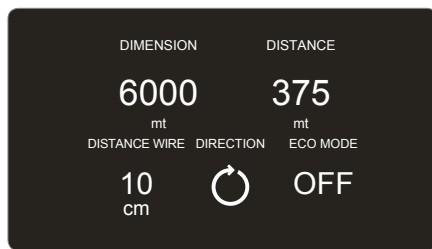

For each area of the garden you must set:

- **dimension.** The indicative size of the work area in square metres;
- **distance.** The distance required by the robot to reach the inside of the area by following the perimeter wire. To ensure that the robot starts working inside the desired area, it is recommended to use the middle of the work area as a reference for the distance. Set the value to 0 for the area where the charging station is positioned;
- **direction.** Shortest direction to reach the work area. The direction can be “clockwise” or “counter-clockwise”. On exiting the charging station, the robot will follow the wire in the set direction;
- **wire distance.** The distance of the robot from the perimeter wire for reaching the work area. Set this value to “0cm” in complex gardens with many obstacles near the perimeter wire and/or gardens with narrow passages;
- **ECO mode.** If enabled and the robot detects that the lawn surface has been mowed, the working time in this area is reduced and the robot will move to the next step.

## General settings



General settings.

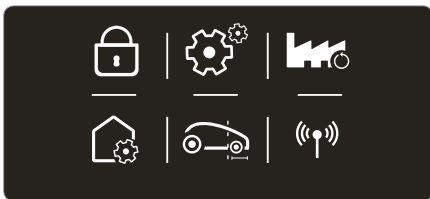

Protection. Allows enabling/disabling/changing the robot's PIN CODE.

To set or change the password, first enter the current PIN CODE and then the new PIN CODE. Upon purchase, the password entered by the manufacturer consists of four numbers (“0000”).

**Choose a number combination for the password that is easy to remember.**



Connectivity. (Only in some models). Allows changing the connection parameters.



This allows setting a correction factor for the alignment and recognition of the charging station. Refer to the robot menu or the APP for more details.



Resets the factory settings.

**All configurations will be lost, the robot and garden settings will have to be configured again. The PIN CODE will not be reset to the default value.**



Sets the distance travelled by the robot after the perimeter wire, before changing direction. Set MIN to allow the robot to travel the minimum possible distance, MAX for the maximum possible distance and MED for the medium distance.

---

## ROBOT SAFETY STOP

---

During use, it may be necessary to stop the robot. In normal conditions, the robot can be stopped with the "OFF" key. In case of danger or when performing any maintenance, it is necessary to stop the robot in safe conditions in order to prevent the blade from accidentally starting. Press the "STOP" key to stop the robot. Disconnect the power plug from the electrical outlet.



### Important

**The robot safety stop is necessary during maintenance and repairs (for example, blade replacement, cleaning operations, etc.).**

To start, proceed as indicated:

- position the robot inside the cutting area;
- press the ON/OFF key and wait a few seconds for the robot to turn on completely.
- press the START/PAUSE key to start the work cycle.

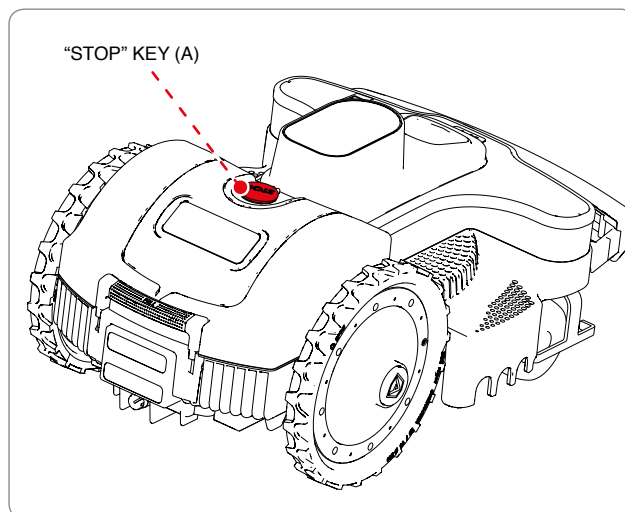

---

## PROLONGED INACTIVITY AND RESTARTING

---

After a long period of inactivity of the robot and before the mowing season, it is necessary to perform a series of operations to guarantee the correct functioning at the time of reuse.

1. Fully charge the battery before winter storage. Recharge the battery at least once every five months.
2. Have the routine maintenance performed by an authorised dealer. This is essential for keeping the robot in good condition. The assistance service usually includes the following operations:
  - total cleaning of the robot, the cutting blade and all the other moving parts;
  - cleaning of the inside of the robot;
  - checking of robot functioning;
  - checking and, if necessary, replacement of any worn parts such as the cutting blade, the brushes (only in robots equipped with brushed motors);
  - checking of the battery capacity;
  - if necessary, the dealer may also load new software.
3. Accurately clean the robot and charging station (see "Robot Cleaning")
4. Check any worn or damaged components such as the cutting blade and evaluate their replacement.
5. Store the robot in a protected and dry place with an ambient temperature between 10° and 20° C, out of reach of foreign elements (children, animals, other foreign objects, etc.). Store the robot at a temperature below 20°C in order to reduce the automatic discharge of the batteries.
6. Disconnect the power plug (A) from the electrical outlet.
7. Cover the charging station (C) to prevent any foreign materials from getting inside (leaves, paper, etc.) and for preserving the contact plates.

## Restarting

Before restarting the robot after a long period of inactivity, proceed as follows:

1. connect the power plug (A) to the electrical outlet;
2. reconnect the main electrical power supply;
3. position the robot inside the charging station;
4. Press the ON/OFF key and wait a few seconds for the robot to turn on completely.
5. The battery LED turns orange and remains fixed for a few seconds during recognition of the charging station.
6. the robot is now ready to be used (see "Programming Mode").

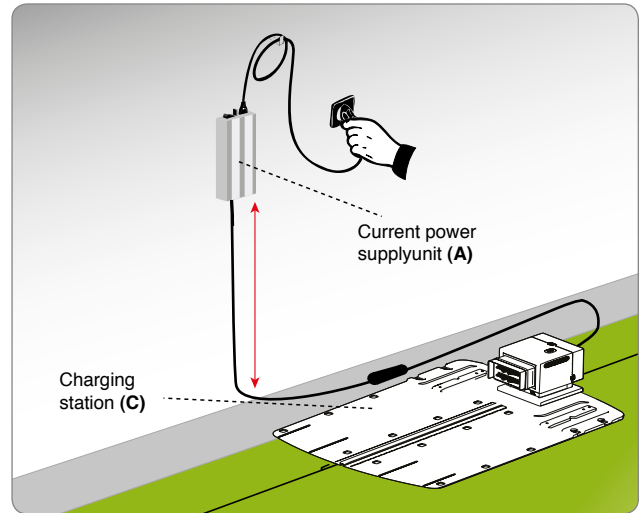

## BATTERY CHARGING AFTER PROLONGED INACTIVITY



### Danger - Attention

**Do not recharge the robot in explosive and flammable environments.**

1. Supply electricity to the charging station and make sure the plates are clean.
2. Position the robot inside the charging station.
3. Press the ON/OFF key and wait a few seconds for the robot to turn on completely.
4. The battery LED turns orange and remains fixed for a few seconds during recognition of the charging station.
5. Make sure the AUTO LED is off, if necessary press the AUTO key to turn it off.
6. At the end of the charging cycle (approx. 6 hours), press the "OFF" key (C).
7. Store the robot in a protected and dry place with an ambient temperature between 10° and 20° C, difficult to reach by children, animals, other foreign objects, etc.

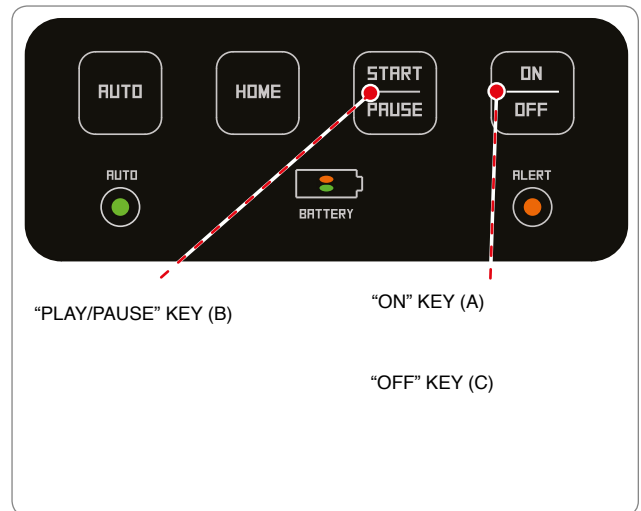

## OPERATING TIPS

Below are some useful operating tips to follow when using the robot:

- even after being suitably informed on the use of the robot, it is always a good idea to simulate some test manoeuvres on first use to identify the commands and main functions;
- check and secure the fastening screws of the main components;
- mow the lawn frequently to avoid excessive growth of the grass;
- do not use the robot to mow grass which is 1 cm (0.40 ") higher than the cutting blade. In case of high grass, lift the cutting blade and then lower it gradually on the following days;
- if the lawn is equipped with an automatic sprinkler system, program the robot to return to the charging system at least one hour before the sprinklers are turned on;
- check the slope of the ground and make sure the maximum values allowed are not exceeded in order to prevent damage to the robot and the sprinklers;
- it is recommended to program the robot so that it does not work more than is necessary, also taking into consideration the different growth rates of the grass in different seasons, so as not to subject it to unnecessary deterioration and reduction of the battery life;
- when using the robot, make sure the work area is clear of people (in particular, children, the elderly or disabled people) and pets in order to prevent safety risks. To minimise the chance of injury, program the robot so that it operates at suitable times of the day.

The manufacturer does not guarantee complete compatibility between the robotic mower and other types of wireless systems, such as remote controls, radio transmitters, acoustic aids, underground electric fences for animals or the like.

## ROUTINE MAINTENANCE

### MAINTENANCE RECOMMENDATIONS



#### Important

**During maintenance, use personal protection equipment indicated by the Manufacturer, especially when working on the blade. Before carrying out any type of maintenance, make sure the robot is turned off (see "Robot Safety Stop").**

### SCHEDULED MAINTENANCE TABLE

Frequency	Part	Type of maintenance	Reference
Weekly	Blade	Clean and check the efficiency of the blade. If the blade is bent or very worn, replace it	See "Robot Cleaning" See "Blade Replacement"
	Battery charging knobs	Clean and remove any rust	See "Robot Cleaning"
	Contact plates	Clean and remove any rust	See "Robot Cleaning"
	Rain sensor	Clean and remove any rust	See "Robot Cleaning"
Monthly	Robot	Clean the robot	See "Robot Cleaning"
Once a year and at the end of the mowing season	Robot	Have the robot serviced at an authorised service centre	See "Prolonged inactivity and restarting"

## ROBOT CLEANING

1. Stop the robot safely (see “Robot Safety Stop”).



### Warning – Caution

**Use protective gloves to prevent cutting your hands.**

2. Clean all the outside surfaces of the robot with a sponge soaked in warm water and a mild detergent. Squeeze well to remove any excess water before use.



### Warning – Caution

**The use of too much water may cause water to penetrate into the device which could damage the electrical parts.**

3. Do not use solvents or benzene so as not to damage the painted surfaces and plastic components.
4. Do not wash the inside parts of the robot and do not use jets of pressurised water so as not to damage the electric and electronic parts.



### Warning – Caution

**In order to avoid irreversible damage to the electric and electronic components, do not immerse the robot, partially or completely, in water because it is not watertight.**

5. Check the lower part of the robot (cutting blade area, and wheels), use a brush suitable to remove deposits and/or residues that may impede the proper functioning of the robot.
6. Remove any grass and leaves from the gripping areas of the robot.
7. Clean the knobs of the battery charger (A), the contact plates (B) and remove any deposits or residuals caused by electric contacts with a dry cloth and, if necessary, with fine sandpaper.
8. Clean the rain sensor (C) and remove any dirt or rust.
9. Clean the inside of the charging station to remove any accumulated residuals.

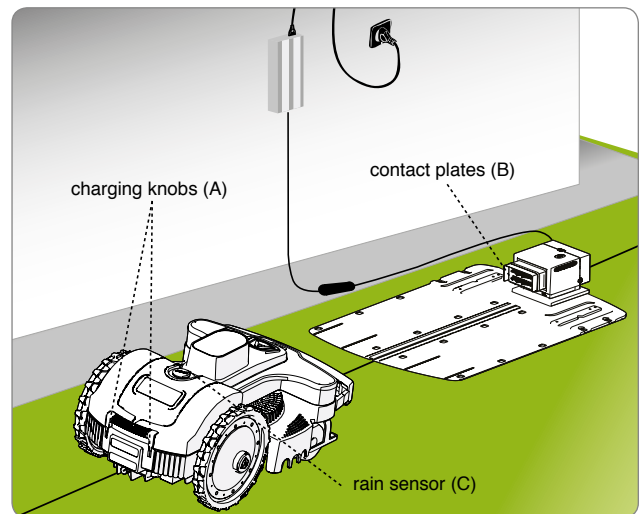

## TROUBLESHOOTING GUIDE

The information below is designed to help identify and correct any faults and/or malfunctions which may occur during operation. Some faults can be fixed by the user, while others require specific technical skills or special expertise and therefore must only be fixed by qualified personnel with certified experience in the specific field of intervention.

When the robot is in an error state and the ALERT light is on or flashing, connect to the robot using the APP on your smartphone to see what the problem is.



**Warning – Caution**

**Safely stop the robot (see “Robot Safety Stop”) in case it is necessary to check the robot, in order to avoid danger of accidental blade starting.**

Problem	Cause	Remedies
Abnormal vibrations The robot is very noisy	Cutting blade damaged	Replace the blade with a new one (see “Blade Replacement”)
	Cutting blade clogged by residuals (tape, cords, plastic fragments, etc.)	Safely stop the robot (see “Robot Safety Stop”). Unclog the blade  <b>Warning – Caution</b> Use protective gloves to prevent injuries to your hands
	The robot was started in the presence of obstacles (fallen branches, forgotten objects, etc.)	Stop the robot safely (see “Robot Safety Stop”)  Remove the obstacle and restart the robot (see “Start up - Automatic mode”)
	Electric motor failure	Have the motor replaced or repaired by your nearest authorised service centre
	Grass too high	Increase the cutting height (see “Adjustment of cutting height”)  Carry out a preliminary cutting of the area with a normal lawnmower
The robot does not position itself correctly inside the charging station	Incorrect positioning of the perimeter wire or power cord of the charging station	Check the connection of the charging station (see “Installation of charging station and power supply unit”)
	Collapsing of ground next to the charging station	Position the charging station on a flat and stable surface (see “Planning of system installation”)
The robot does not behave correctly around the flowerbeds	Perimeter wire laid incorrectly	Reposition the perimeter wire correctly (counter-clockwise direction) (see “Installation of perimeter wire”)
The robot works at the wrong time	Clock was set incorrectly	Reset the clock of the robot (see “Programming Mode”)
	Working time was set incorrectly	Reset the working time (see “Programming Mode”)

Problem	Cause	Remedies
The work area is not completely mowed	Not enough work hours	Extend the working time (see "Programming Mode")
	Cutting blade clogged with deposits and/or residuals	Stop the robot safely (see "Robot Safety Stop")  <b>Warning – Caution</b> <b>Use protective gloves to prevent injuries to your hands.</b> Clean the cutting blade
	Cutting blade worn out	Replace the blade with an original spare part (see "Blade replacement")
	Work area too big compared to the actual capacity of the robot	Adjust the work area (see "Technical specifications")
	The batteries are about to run out.	Replace the batteries with original spare parts (see "Battery replacement")
	The batteries do not charge completely	Clean and remove any rust from the contact points of the batteries (see "Robot Cleaning").
Secondary area not completely mowed	Programming error	Correctly program the secondary area (see "Programming Mode")
 Slow orange flashing light	Date and time not set	Connect to the robot using the APP on your smartphone to update the date and time
	Cutting blade damaged	Replace the blade with a new one (see "Blade Replacement").
	Cutting blade clogged by residuals (tape, cords, plastic fragments, etc.).	Safely stop the robot (see "Robot Safety Stop").  <b>Danger - Attention</b> <b>Use protective gloves to prevent cutting your hands.</b> Unclog the blade.
	Grass too high	Increase the cutting height (see "Adjustment of cutting height")
 Fast orange flashing light	The robot is lifted from the ground	Check that the robot is not blocked or obstructed by any object. Clean and remove any grass residues from under the body that may block the sensors.
	After pressing the OFF key, the LED flashes quickly	Connect to the robot using the APP on your smartphone to enter the robot's PIN
	The perimeter wire is not connected properly (broken cable, no electrical connection, etc.)	Check the functioning of the electrical power supply, the correct connection of the power supply unit and charging station (see "Installation of charging station and power supply unit").
	Robot outside the perimeter on a slope	Mark off the area with too much slope (see "Planning of system installation")
	Robot outside the perimeter	Check that the wire has been installed correctly (too deep, next to metallic objects, distance between the wire marking the two elements less than 70 cm, etc.) (see "Planning of system installation")
Robot inside a flower bed	Reposition the perimeter wire correctly (counter-clockwise direction) (see "Installation of perimeter wire").	

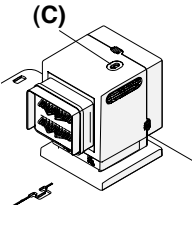

Problem		Cause	Remedies
 Fixed orange light		Irrecoverable error.	Turn the robot off and on. If the problem persists, contact your nearest authorised service centre.
	The led (c) does not turn on	No power supply	Make sure the power supply unit is correctly connected to the power outlet
		Interrupted fuse	Have the fuse replaced by your nearest authorised service centre
	The transmitter LED (C) is on	Interrupted perimeter wire	Stop the robot safely (see “Robot Safety Stop”). Disconnect the power plug from the power supply unit. Join the perimeter wire

## PART REPLACEMENT

### RECOMMENDATIONS FOR REPLACING PARTS



#### Important

Replace and repair any parts according to the manufacturer's instructions, or contact the service centre if these operations are not included in the manual.

### BATTERY REPLACEMENT



#### Important

Replace the batteries at an authorised service centre.

### BLADE REPLACEMENT

1. Stop the robot safely (see “Robot Safety Stop”).



#### Important

Use protective gloves to prevent injuries to your hands.

For replacement, use only the original blade suitable for the device.

**Model:** 8040BA0, B040BAH

**Cutting blade code:** 075Z07800A

2. Turn the robot over and position it so as not to ruin the covering hood.
3. Unscrew the screws (B) to remove the blade (A).
4. Insert a new blade and fasten the screws.
5. Turn the robot back over to its operating position.

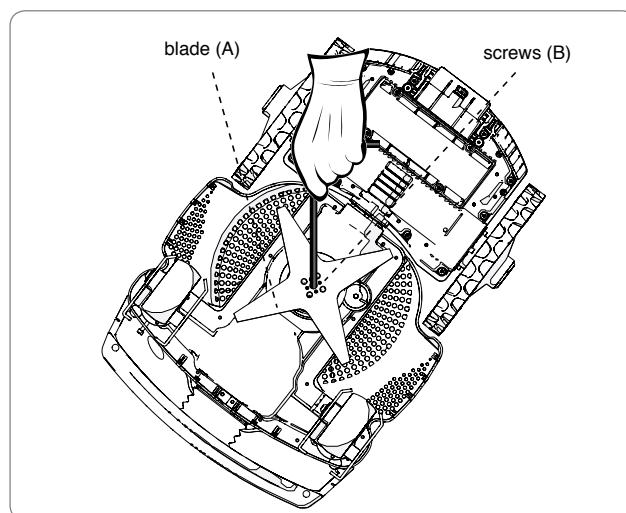

---

## ROBOT DISPOSAL

---

- At the end of its useful lifespan, this product is classified as WEEE (waste electrical and electronic equipment). It must therefore not be disposed of as normal domestic waste, as mixed urban waste (undifferentiated) or as separated urban waste (differentiated).
- When it is time for disposal, the user must make sure that the product is recycled in compliance with the requirements of the local laws; in particular, electric and electronic components must be separated and sorted in authorised waste disposal centres for WEEE, or the product must be taken intact to the dealer when a new purchase is made. Abusive disposal of WEEE is punished by fines established by laws in force in the areas where said disposal occurs.
- Dangerous substances contained in electric and electronic equipment have potentially harmful effects on the environment and people's health so the user has a fundamental role in contributing to reuse, recycling and any other way of recovering WEEE.
- All parts, to be specifically separated and disposed of, are marked..



### Danger - Attention

**WEEE - Waste Electric and Electronic Equipment (WEEE) can contain dangerous substances with potentially harmful effects on the environment and people's health. WEEE must be disposed of correctly and only in specific disposal centres.**

- Packaging - Product packaging is made with recyclable materials and must be disposed of in a sustainable manner in special disposal containers or authorised waste disposal centres.
- Batteries - Old or exhausted batteries contain harmful substances for the environment and people's health so must not be disposed of as normal domestic waste. The user must dispose of batteries in a sustainable way, in specific disposal containers or in authorised waste disposal centres.

**ZUCCHETTI Centro Sistemi S.p.A. Via Lungarno 305/A Terranuova B.ni (AR) ITALY**

Declares and assumes liability that the product:

battery-powered automatic lawnmower robot, model 8040BA0, B040BAH complies with the basic requisites for safety, health and environmental protection provided for by the following European Union directives:

**Machinery directive 2006/42/EC, electromagnetic compatibility directive 2014/30/EU, Radio (RED) directive 2014/53/EU, RoHS directive 2011/65/EU, WEEE directive 2012/19/EU, directive for noise emission in the environment 2005/88/EC;**

complies with the following harmonised standards:

EN 50636-2-107:2015 + A1:2018 and EN 60335-1:2012 + AC:2014 + A11:2014 + A13:2017 (**safety**);

EN 62233:2008 (**electromagnetic fields**);

EN 55014-1:2017 (**emission**);

EN 61000-3-2:2014 and EN 61000-3-3:2013 (**emission**);

EN 55014-2:2015 (**immunity**);

EN 50419:2006 (**WEEE – Equipment marking**)

ETSI EN 301 489-1 V2.1.1 (**Electromagnetic compatibility**)

ETSI EN 301 489-17 V3.1.1 (**Electromagnetic compatibility**)

ETSI EN 300 328 V2.1.1 (**Radio Spectrum Efficiency**)

ETSI EN 303 447 V1.1.1 (**Radio Spectrum Efficiency**)

Models equipped with "Connect module (GPS, GPRS)":

ETSI EN 301 511 V12.5.1 (**Radio Spectrum Efficiency**)

also declares that, pursuant to directive 2005/88/EC, the LWA sound power level, out of a significant sample is 63 dB ± 2.0 dB (weighted on A curve and referred to 1 pW), that the guaranteed LWA sound power level is less than 65 dB (weighted on A curve and referred to 1 pW) and that the technical folders in compliance with directives 2005/88/EC and 2006/42/EC are available c/o Zucchetti Centro Sistemi S.p.A. via Lungarno 305/a, Terranuova B.ni (ar), Italy.

Terranuova B.ni 05/10/2020

Bernini Fabrizio  
(CEO)



## WARRANTY RULES

Zucchetti Centro Sistemi S.p.A (ZCS) ensures application of all the requirements of European Directive 1999/44/CE. In particular, the warranty covers any material or manufacturing defects for a period of 2 (two) years from the original date of purchase.

ZCS does not warrant uninterrupted or error-free operation of the product, nor shall it be liable for damage caused by the failure to follow instructions. Furthermore, this warranty does not cover aesthetic damage, such as scratches, nicks and dents; consumable materials such as batteries, unless the damage was caused by a defect in materials or workmanship; damage caused by the use of the product with accessories not manufactured or sold by ZCS; damage caused by accidents, abuse, misuse, floods, fire or other natural events or external causes; damage caused by operations performed by service providers not authorised by ZCS; or damage to a product that has been modified or altered without the written permission of ZCS.

ZCS shall have the exclusive right to repair or replace (with a new or refurbished product) the product or components or to offer, at its sole discretion, full refund or the purchase price. When a refund is given, the product for which you received the refund must be returned to ZCS and it becomes the property of ZCS.

During the warranty period, ZCS shall, at its sole discretion, see to repairing or replacing any parts that fail in normal use. The repair or replacement may include the use of newly manufactured or refurbished used parts as ZCS sees fit. ZCS also has the right to use replacement units, parts or components of similar value and design. The cost of parts or labour for repairs or replacements will not be charged to the customer, who instead will be charged for the shipping costs. When replacing a product or part, any replacement element becomes the property of the user and the replaced part becomes the property of ZCS, depending on the case.

This warranty does not affect the legal rights of customers under applicable state or national laws, except for charges established by these laws to be borne by the customer to enforce this warranty.

The warranty is limited to the country of purchase and is enforced at the retail outlet where the robot was purchased or at your nearest service centre. The faulty robot must be returned in person to your vendor or to your nearest service centre. In the case of delivery by courier, to be paid by the purchaser, the robot must be packed in its original packaging and accompanied by a copy of the invoice or purchase receipt, including the date of purchase, serial number and description of the problem.

### CONDITIONS AND LIMITATIONS

- For the application methods of this warranty and for any information, contact your dealer.
- This warranty is valid only if:
  - the faulty product is brought back with the original legible invoice or purchase receipt showing the purchase date and name of the dealer.
- This warranty is void if:
  - the product has not been used according to the instructions of use and maintenance;
  - the installation or use did not comply with the instructions of use;
  - the serial number has been cancelled or made illegible;
  - any unauthorised peripheral device has been used or the product has been modified;
  - unoriginal spare parts or accessories have been used;
  - a part or an accessory has been tampered with;
  - maintenance has been performed by the customer or by unauthorised third parties;
  - the robot, power supply unit, charging station or accessories has faults caused by atmospheric agents such as lightning, avalanches, landslides, power surges, storms, floods, natural disasters, etc.
- Excluded from the warranty and limitations:
  - the warranty does not cover parts subject to wear following use, such as brushes, cutting blades, perimeter wire, pegs, belts, wheels, blades, cables and connection cords;
  - external parts and plastic supports that do not present manufacturing defects. Discoloration of plastic due to natural reasons or chemicals;
  - the battery warranty is limited only to manufacturing defects in the first six months of life;
  - the motors have a warranty of 2 years with limit at 3000 working hours.

### HOW TO REQUEST WARRANTY SERVICE

To request warranty service and specific instructions on where and how to return the ZCS product for service, contact the dealer where you purchased the robot or your nearest service centre. To enforce the warranty right, the customer must present an original or a copy of the invoice or purchase receipt of the product issued by the original dealer. The limited warranty is only valid and enforceable in the country where ZCS or its authorised dealers originally sold the product.

### ADDITIONAL DEFINITIONS

#### On-site support

- The customer is not entitled to on-site support of the product, not even during the warranty period.
- Should on-site support be necessary, the call and the hourly rate applied by the service centre will be charged to the customer.

#### Suggestions

- Keep the original packaging.
- Keep the invoice or purchase receipt (cause for loss of warranty).

#### Please note

- The customer is obliged to carefully read the instruction booklet and to follow all the information contained in it.